



Rev. H | 2018.04

# LPT-A-VLT

Ammonia Vent Line Transmitter

## TABLE OF CONTENTS

<b>1 POLICIES</b> .....	<b>4</b>
1.1 Important Note .....	4
1.2 Warranty Policy .....	4
1.3 Service Policy .....	5
1.4 Copyrights .....	5
1.5 Disclaimer .....	6
1.6 Revisions .....	6
<b>2 INTRODUCTION</b> .....	<b>7</b>
2.1 General Description .....	7
2.2 Key Features .....	7
<b>3 INSTRUMENT SPECIFICATIONS</b> .....	<b>8</b>
3.1 Technical Specifications .....	8
3.2 Enclosure Dimensions .....	10
<b>4 SENSOR SPECIFICATIONS</b> .....	<b>10</b>
4.1 Special Considerations for Sensors .....	11
<b>5 FEATURES</b> .....	<b>11</b>
5.1 Exterior Enclosure - Front .....	11
5.2 Exterior Enclosure - Back .....	12
5.3 Interior Enclosure - Door .....	11
5.4 Interior Enclosure - Base .....	14
<b>6 INSTALLATION</b> .....	<b>15</b>
6.1 General Safety Warnings .....	15
6.2 Protection Against Electrical Risks .....	15
6.3 Protection Against Mechanical Risks .....	15
6.4 System Installation .....	16
6.4.1 Wet Environment Considerations .....	16
6.4.2 EMI and RF Interference Considerations .....	16
6.5 Enclosure Mounting Components .....	16
6.6 Wiring Power Connections .....	16
6.6.1 Power Connection Supplied by Installer .....	17
6.6.2 Power Connection Supplied by QCC or FCS Controller .....	18
6.7 Relay Connection .....	19
6.8 Wire Gauge vs Run Length .....	20
6.8 Open Loop .....	21
<b>7 SYSTEM OPERATION &amp; CONFIGURATION</b> .....	<b>21</b>
7.1 Power Up and Warm-up .....	21
7.2 Display Select .....	22

- 7.3 Enable or Disable the Internal Buzzer / Audible Alarm ..... 22
- 7.4 Select the Output Signal ..... 23
- 7.5 Fault Detection..... 23
- 7.6 Test Functions ..... 23
  - 7.6.1 Test Relay and Buzzer..... 23
  - 7.6.2 Test Voltage Output to Test Points TP1 - TP2 ..... 24
- 7.7 Relay Operation / Set the Alarm Setpoint..... 24
- 8 CALIBRATION..... 25**
  - 8.1 Calibration Specifications..... 25
    - 8.1.1 Gas..... 25
    - 8.1.2 Regulators & Flow..... 25
    - 8.1.3 Adapters ..... 25
    - 8.1.4 Calibration Frequency ..... 25
    - 8.1.5 Gas Testing Frequency - Bump Testing ..... 26
    - 8.1.6 Non-Intrusive Calibration..... 26
  - 8.2 Calibration Procedure..... 26
  - 8.3 Exit Calibration..... 32
  - 8.4 Sensor Replacement ..... 32
- 9 ACCESSORIES ..... 32**
  - 9.1 Magnetic Wand..... 32
  - 9.2 Metal Protective Guard ..... 32
  - 9.3 Calibration Kit ..... 33
- 10 MAINTENANCE ..... 33**
- 11 TROUBLE SHOOTING ..... 34**

## 1 POLICIES

### 1.1 Important Note

Read and understand this manual prior to using this instrument. Carefully read the warranty policy, service policy, notices, disclaimers and revisions on the following pages.

This product must be installed by a qualified electrician or factory trained technician and according to instructions indicated in this manual. This instrument should be inspected and calibrated regularly by a qualified and trained technician. For more information, refer to Sections *8 Calibration* and *10 Maintenance* of this manual.

This instrument has not been designed to be intrinsically safe. For your safety, **do not** use it in classified hazardous areas (explosion-rated environments).

**INSTRUMENT SERIAL NUMBER:**

---

**PURCHASE DATE:**

---

**PURCHASED FROM:**

---

### 1.2 Warranty Policy

Critical Environment Technologies Canada Inc. (CETCI), also referred to as the manufacturer, warrants this instrument, (excluding sensors, battery packs, batteries, pumps and filters) to be free from defects in materials and workmanship for a period of **two years from the date of purchase from our facility**. The sensors have a warranty period of **one year on a pro-rated basis from the date of purchase from our facility**. If the product should become defective within this warranty period, we will repair or replace it at our discretion.

The warranty status may be affected if the instrument has not been used and maintained as per the instructions in this manual or has been abused, damaged, or modified in any way. This instrument is only to be used for purposes stated herein. The manufacturer is not liable for auxiliary interfaced equipment or consequential damage.

Due to ongoing research, development, and product testing, the manufacturer reserves the right to change specifications without notice. The information contained herein is based on data considered accurate. However, no warranty is expressed or implied regarding the accuracy of this data.

All goods must be shipped to the manufacturer by prepaid freight. All returned goods must be pre-

authorized by obtaining a Returned Merchandise Authorization (RMA) number. Contact the manufacturer for a number and procedures required for product transport.

### 1.3 Service Policy

CETCI maintains an instrument service facility at the factory. Some CETCI distributors / agents may also have repair facilities; however, CETCI assumes no liability for service performed by anyone other than CETCI personnel.

Repairs are warranted for 90 days after date of shipment (sensors have individual warranties).

Should your instrument require non-warranty repair, you may contact the distributor from whom it was purchased or you may contact CETCI directly.

Prior to shipping equipment to CETCI, contact our office for a Returned Merchandise Authorization (RMA) number. All returned goods must be accompanied with an RMA number.

If CETCI is to do the repair work, you may send the instrument, prepaid, to:

**Attention: Service Department**  
**Critical Environment Technologies Canada Inc.**  
**Unit 145, 7391 Vantage Way**  
**Delta, BC, V4G 1M3**

Always include your RMA number, address, telephone number, contact name, shipping / billing information, and a description of the defect as you perceive it. You will be contacted with a cost estimate for expected repairs, prior to the performance of any service work.

For liability reasons, CETCI has a policy of performing all needed repairs to restore the instrument to full operating condition.

Pack the equipment well (in its original packing if possible), as we cannot be held responsible for any damage incurred during shipping to our facility.

### 1.4 Copyrights

This manual is subject to copyright protection; all rights are reserved. Under international and domestic copyright laws, this manual may not be copied or translated, in whole or in part, in any manner or format, without the written permission of CETCI.

All software which CETCI utilizes and / or distributes holds a proprietary interest and is also subject to copyright protection and all rights are reserved. No party may use or copy such software in any manner or format, except to the extent that CETCI grants them a license to do so. **IF SOFTWARE IS BEING LOADED ONTO MORE THAN ONE COMPUTER, EXTRA SOFTWARE LICENSES MUST BE PURCHASED.**

## 1.5 Disclaimer

Under no circumstances will CETCI be liable for any claims, losses or damages resulting from or arising out of the repair or modification of this equipment by a party other than CETCI service technicians, or by operation or use of the equipment other than in accordance with the printed instructions contained within this manual or if the equipment has been improperly maintained or subjected to neglect or accident. Any of the foregoing will void the warranty.

Under most local electrical codes, low voltage wires cannot be run within the same conduit as line voltage wires. It is CETCI policy that all wiring of our products meet this requirement. It is CETCI policy that all wiring be within properly grounded (earth or safety) conduit.

## 1.6 Revisions

This manual was written and published by CETCI. The manufacturer makes no warranty or representation, expressed or implied including any warranty of merchantability or fitness for purpose, with respect to this manual.

All information contained in this manual is believed to be true and accurate at the time of printing. However, as part of its continuing efforts to improve its products and their documentation, the manufacturer reserves the right to make changes at any time without notice. Revised copies of this manual can be obtained by contacting CETCI or visiting [www.critical-environment.com](http://www.critical-environment.com).

In no event will CETCI, its officers or employees be liable for any direct, special, incidental or consequential damages resulting from any defect in any manual, even if advised of the possibility of such damages. Should you detect any error or omission in this manual, please contact CETCI at the following address:

### **Critical Environment Technologies Canada Inc.**

Unit 145, 7391 Vantage Way, Delta, BC, V4G 1M3, Canada

Toll Free: +1.877.940.8741

Telephone: +1.604.940.8741

Fax: +1.604.940.8745

Email: [marketing@cetci.com](mailto:marketing@cetci.com)

Website: [www.critical-environment.com](http://www.critical-environment.com)

## 2 INTRODUCTION

### 2.1 General Description

Thank you for purchasing our LPT-A-VLT Ammonia Vent Line Transmitter (P/N: LPT-A-VLT-NH3-S).

The LPT-A-VLT Ammonia Vent Line gas detector is designed for continuous monitoring of ammonia levels in the vent line of refrigeration systems. More specifically, this gas detector is designed for the detection of equipment failure in ammonia plant vent stack applications.

**IMPORTANT: This gas detector is NOT designed to monitor ammonia in applications requiring human health safety levels detection and is not designed to protect people from toxic gas concentrations.** The lowest reading the sensor will detect is above the recommended exposure limit to ammonia.

**NOTE:** CETCI does manufacture ammonia gas detectors that meet human health safety levels, if that is the required application. If you have any questions, please do not hesitate to contact our service department for technical support.

Using a ¾" cast steel coupler, the LPT-A-VLT Ammonia Vent Line transmitter is to be mounted indoors on the ammonia vent relief stack above the pressure relief valve, or mounted outside on the relief header above the roofline.

The LPT-A-VLT is **not** intended for use in hazardous rated areas..

This analog transmitter features a back lit, LCD digital display (refer to Section 3.1 *Technical Specifications*), analog output signal, one dry relay contact, audible alarm, and the enclosure is IP54 rated. It can be configured to alarm at a pre-determined setpoint and to activate a remote strobe or horn, or communicate with a Controller, BAS, PLC or similar control panel to activate or shut down equipment as required.

If after reading through the manual, you have any questions, please do not hesitate to contact our service department for technical support.

### 2.2 Key Features

- Single, internal ammonia sensor
- Graphic LCD display (user selectable function)
- Internal audible alarm
- 3-wire VDC or 4-wire VAC power
- 24 volt DC or AC power (nominal)
- Linear 4 - 20 mA or 0 - 10 volt output signal
- 1 dry contact relay, 30 volt 2 amps maximum
- IP54 rated water / dust tight, corrosion resistant enclosure
- RoHS compliant circuit boards
- Auto resetting fuses

## 3 INSTRUMENT SPECIFICATIONS

### 3.1 Technical Specifications

#### SENSOR

Sensor Type	Catalytic
Gas Type	Ammonia (NH <sub>3</sub> )
Range	0 - 3.00% volume range Measures to 2 decimal places, tolerant to 15% volume
Response Time T <sub>90</sub>	< 30 seconds

#### MECHANICAL

Enclosure	ABS / Polycarbonate, IP54 rated. Copper coated interior to reduce RF interference.
Weight	825 g / 29 oz
Size (transmitter only)	127 mm x 127 mm x 60.96 mm / 5.0 in x 5.0 in x 2.4 in
Coupler	19 mm / 3/4 in NPT, cast steel
Sensor Assembly Length (including coupler)	98.5 mm / 3.875 in

#### ELECTRICAL

Power Requirement	3-wire mode 16 - 30 VDC, 3 W, Class 2 4-wire mode 12 - 27 VAC, 50-60 Hz, 3 VA, Class 2 Use Class 2 transformer. Refer to Section 6.6 <i>Wiring Power Connections</i>
Current Draw	125 mA @ 24 VDC
Wiring	VDC (or ground referenced AC) three conductor shielded 18 awg (or larger) stranded within conduit VAC four conductor shielded 18 awg stranded within conduit Refer to Section 6.8 <i>Wire Gauge vs. Run Length</i>
Fuses	Automatic resetting thermal

#### USER INTERFACE

Display	Graphic LCD, grey border. Text prompting for calibration operation and fault indications. Installer configurable to suppress all other displays.
Magnetic Sensor	Use the magnetic wand to initiate calibration without opening enclosure.



## INPUTS / OUTPUTS

Outputs	Linear 4 - 20 mA
	Maximum 216 $\Omega$ load (wiring plus termination resistor) @ 12 VDC Maximum 316 $\Omega$ load (wiring plus termination resistor) @ 12 VAC
Relay	Voltage 0 - 10 volt Minimum 1k ohm load
	One SPDT dry contact relay, rated 2A @ 30V maximum

## ENVIRONMENTAL

Operating Temperature	-20°C to 40°C (-4°F to 104°F)
Operating Humidity	15 - 90% RH non-condensing

## CERTIFICATIONS

Model: LPT-A-VLT-NH3-S  
 S/N: LPTAC1601H00374  
 Rating: 16-30 VDC, 3W, Class 2  
 12-27 VAC, 50-60 Hz 3VA, Class 2



CERTIFIED FOR ELECTRIC SHOCK & ELECTRICAL FIRE HAZARD ONLY. LA CERTIFICATION ACNOR COUVRE UNIQUEMENT LES RISQUES DE CHOC ELECTRIQUE ET D'INCENDIE D'ORIGINE ELECTRIQUE.

Conforms to: CSA-C22.2 No. 205-12, UL508 (Edition 17):2007

Conforms to: EMC Directive 2004/108/EC, EN 50270:2006, Type 1, EN61010

Conforms to: FCC. This device complies with Part 15 of the FCC Rules. Operation is subject to the following two conditions: (1) This device may not cause harmful interference, and (2) this device must accept any interference received, including interference that may cause undesired operation.

### 3.2 Standard Enclosure Dimensions

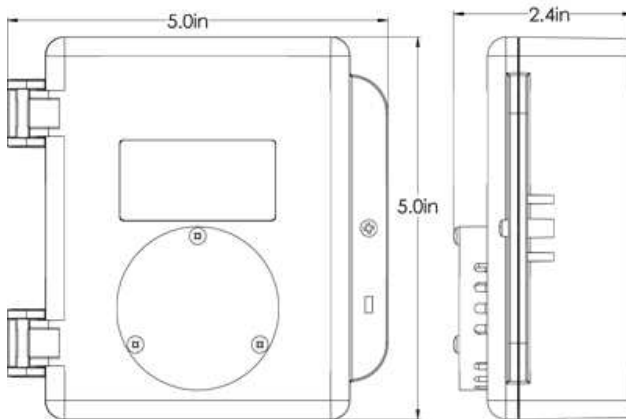

The area required for enclosure door to be open 90 degrees is 178 mm / 7 in or 254 mm / 10 in for fully open.

### 4 SENSOR SPECIFICATIONS

The LPT-A-VLT-NH3-S comes with a catalytic ammonia sensor potted inside the 5cm / 2 in long pipe fitting that protrudes from the back of the enclosure.

The ammonia sensor has a standard measurement range of 0 - 3.00% vol or 0 - 30,000 ppm.

The ammonia sensor has a lifespan of approximately 2 to 3 years in air. Exposure to very high concentrations of ammonia or prolonged exposure to moderate to high concentrations can poison the sensor, leaving it useless for detection.

## 4.1 Special Considerations for Sensors

If you install and power up the LPT-A-VLT Ammonia Vent Line transmitter as soon as it arrives, the sensor will require about a 5 minute warm up period. The sensor goes through a burn in period at our factory so it is ready for operation upon arrival. If the device is not installed within two weeks of delivery, the sensor may require a longer warm up time to stabilize and provide accurate readings (approximately 48 hours).

During calibration, when flowing span gas on an ammonia sensor, if the reading climbs higher than the calibration point after applying gas for 3 minutes, use that reading as the calibration point.

Silicone, lead and chlorinated hydrocarbon vapours can poison catalytic sensors.

A bump test will help you determine if a sensor requires calibration. If the sensor still does not respond as it should after a successful calibration, it probably requires replacing.

Temperature affects calibration. It is important to ensure the gas is at the appropriate temperature during calibration. If the sensor is being used in an extreme temperature range, calibration should be done in that same temperature range.

## 5 FEATURES

### 5.1 Exterior Enclosure - Front



NUMBER	FEATURE	FUNCTION
❶	Door Hinge	Secures door
❷	Display with gray border	Indicates transmitter operation
❸	Door Screw	Secures door
❹	Splash Guard	Covers unused sensor vent, protects from water/dust ingress, IP545 rated
❺	Padlock Opening	For security padlock
❻	Magnetic Calibration Trigger Point	Area to touch the magnetic wand to enter/exit calibration without opening enclosure
❼	13 mm / 1/2 in water tight cable restraint	Water tight conduit entry for shielded 18 awg stranded cable. For outdoor applications, weather proof and UV protected cable is suggested.

## 5.2 Exterior Enclosure - Back

The sensor is potted into a 5 cm / 2 in long pipe fitting that protrudes from the back of the enclosure.

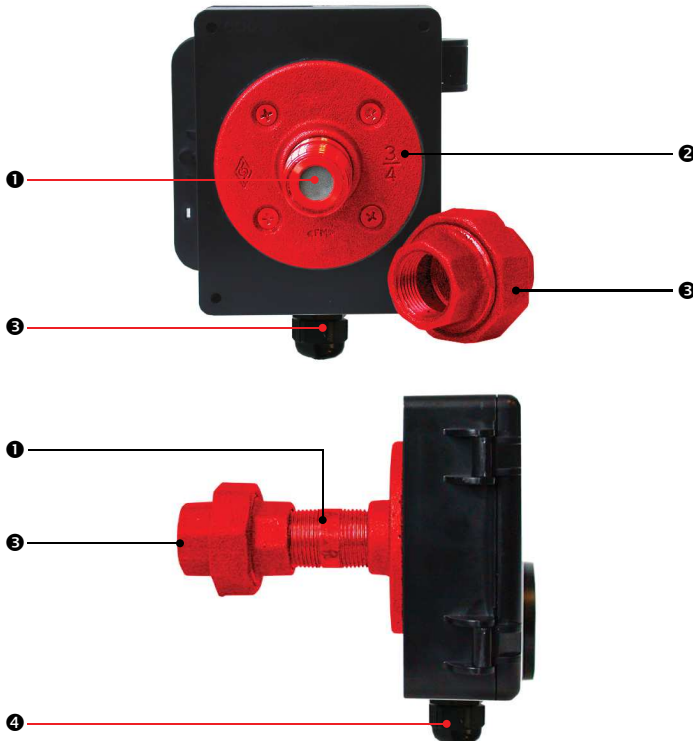

NUMBER	FEATURE
①	5 cm / 2in pipe with potted sensor, screws into the cast steel mounting plate
②	Cast steel sensor mounting plate
③	19 mm / 3/4 in cast steel coupler for connecting to mounting pipe
④	13 mm / 1/2 in water tight cable restraint. If using conduit, replace with liquid tight type conduit fitting.

### 5.3 Interior Enclosure - Door

Because the sensor is potted behind the enclosure, it is connected to the sensor board using the remote sensor terminal.

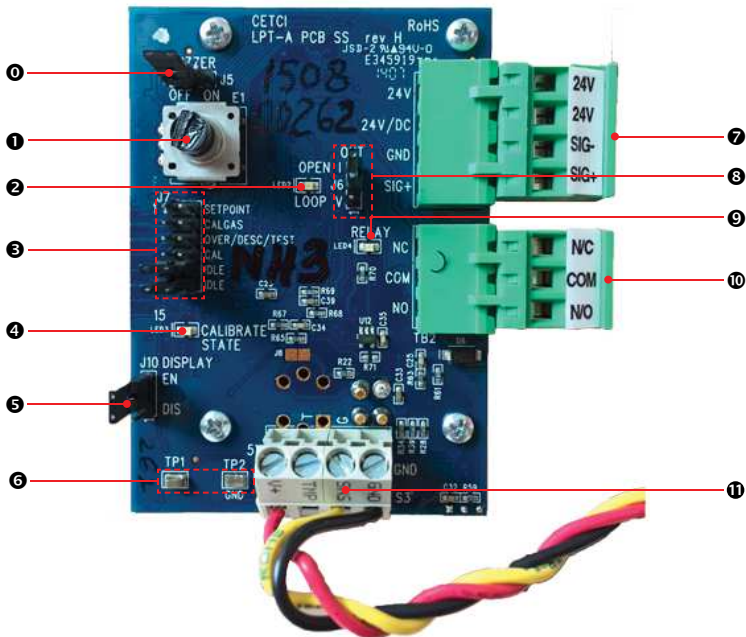

NUMBER	FEATURE	FUNCTION
①	J5 Buzzer Enable	The jumper that enables / disables the buzzer.
②	Rotary Encoder	Sets calibration values, etc. with the jumpers.
③	Open Loop LED	Lights if there is no connection for current output (always lit in voltage output mode).
④	J7 Jumper Bank	For calibration & test functions.
⑤	Calibrate State LED	Further prompting for calibration operation.

5	J10 Display Enable	Enables / disables the display of the measured gas level.
6	Test Points: TP1 & TP2	For measuring voltage output.
7	TB1 Wiring Terminal	Pluggable terminal for Power & signal output.
8	Output Select	Select either current or voltage output.
9	Relay LED	Indicates (when on) that the gas level is above the trip point (the relay will indicate alarm level).
10	TB2 Relay Terminal	Pluggable terminal for relay connections.
11	Remote Sensor Terminal	Terminal used to connect the potted sensor.

## 5.4 Interior Enclosure - Base

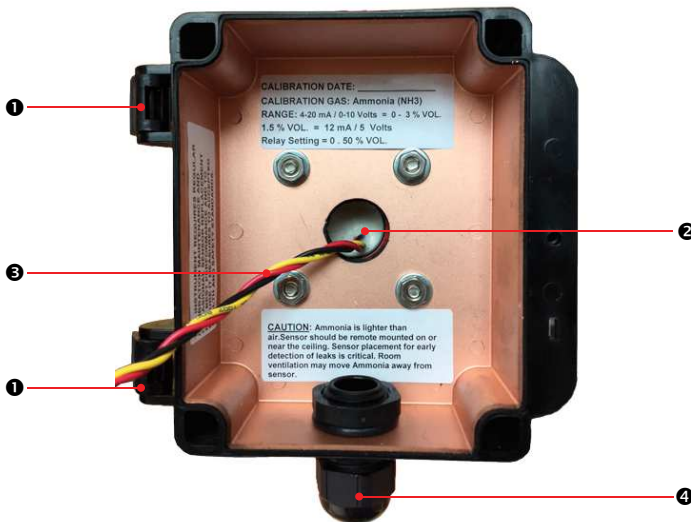

NUMBER	FEATURE
1	Door Hinge
2	Potted sensor is installed beyond this opening
3	Potted sensor wires that connect to the Remote Sensor Terminal
4	13 mm / 1/2 in water tight cable restraint. If using conduit, replace with liquid tight type conduit fitting.

## 6 INSTALLATION

### 6.1 General Safety Warnings

LPT-A-VLT Ammonia Vent Line transmitter is intended to be permanently mounted indoors on the ammonia vent relief stack above the pressure relief valve, or permanently mounted outside on the relief header above the roofline. When installed outdoors, the LPT-A-VLT-NH3-S should be protected from extreme weather / temperature conditions.

The LPT-A-VLT-NH3-S requires no assembly and virtually no maintenance other than regular calibration of the integral and/or remote sensors and ensuring that excess water or dust is not somehow entering the enclosure and physically damaging the circuit board or internal components. There are no serviceable elements other than the calibration instructions outlined in this manual. There are no replaceable components except the sensor.

### 6.2 Protection Against Electrical Risks

Disconnect all power before servicing. There may be multiple power sources. Power supply may have a building installed circuit breaker / switch that is suitably located and easy to access when servicing is required. Appropriate markings should be visible at the circuit breaker / switch that is supplying power to the transmitter.

This device may interfere with pacemakers. Modern pacemakers have built-in features to protect them from most types of interference produced by other electrical devices you might encounter in your daily routine. If you have a pacemaker, follow your healthcare provider's instructions about being around this type of equipment.

### 6.3 Protection Against Mechanical Risks

The door of the enclosure can be removed if absolutely necessary to facilitate installation of the base but it is not recommended on this device. Extreme care and caution must be exercised when removing the door to avoid damaging the hinges. The door should only be removed when absolutely required. Any damage occurring from door removal will not be covered under warranty.

Grasp the door with one hand, being careful not to make contact with any of the internal components (circuit board), grasp the base with your other hand. Tug on the base and pull straight apart. **DO NOT TWIST.** The section of the hinges located on the base should "snap" apart from the part of the hinges located on the door.

After installation, locate the lid hinges over the installed base hinges and pull toward you. The hinges should easily "snap" back into place.

The enclosure has one screw securing the door to the base for electrical safety and provides an opening to allow the user to apply a padlock or tie wrap if they desire the transmitter to be locked. Refer to Section 5.1 *Exterior Enclosure - Front*.

Be aware that the hinged door that could potentially pinch fingers and the sharp edges and/or jumper pins on the board could potentially prick or cut fingers if not handled carefully.

## 6.4 System Installation

The LPT-A-VLT-NH3-S should be installed on the vent stack pipe using the cast steel coupler, no more than 0.3 to 0.6 m / 1 to 2 ft from the discharge stack.

The bottom conduit entry point on the enclosure has been fitted with a 12.7 mm / ½ in water tight cable restraint. If conduit is being used, replace the cable restraint with a liquid tight type conduit fitting. The clearance from the PCA to the base enclosure is 12.7 mm / ½ in. **Do not use a conduit connector that has more than 12.7 mm / ½ in of thread length.** If the transmitter is installed outdoors, it is suggested to use weather proof and UV protected cable.

**NOTE:** When mounting the enclosure, allow enough room to allow the door to be opened fully to access the internal adjustments.

### 6.4.1 Wet Environment Considerations

The factory installed splash guard that covers the (unused) sensor vent in the front of the enclosure protects the device from water and dust ingress.

Any water or physical damage to the transmitter that occurs from the installer drilling their own installation holes will not be covered under warranty. **If using, the conduit fitting entering the LPT-A-VLT-NH3-S enclosure must be the liquid tight type.**

### 6.4.2 EMI and RF Interference Considerations

All electronic devices are susceptible to EMI (Electromagnetic Interference) and RFI (Radio Frequency Interference). Our transmitters have been designed to reduce the effects of these interferences and we meet CSA FCC and CE requirements for these type of devices. However there are still circumstances and levels of interference that may cause our equipment to respond to these interferences and cause them to react as if there has been gas detected.

There are some installation procedures that will reduce the likelihood of getting faulty readings:

1. Locate the transmitters and Controllers out of the way from normal foot traffic and high energy equipment.
2. Confirm the devices are properly grounded using conduit and shielded cabling.
3. Inform operators and technical staff working in the surrounding area to be aware of these possible conditions and that two way radios, Bluetooth enabled devices, cell phones and other electrical equipment may interfere with the response of the gas detectors.

## 6.5 Enclosure Mounting Components

The LPT-A-VLT-NH3-S comes with a 1.9 cm / 3/4 in NPT, cast steel coupler attached to the pipe with the potted sensor . The coupler should be used to secure the device to the mounting pipe on the vent stack.

## 6.6 Wiring Connections

The LPT-A-VLT-NH3-S analog transmitter is a low voltage powered device. Any application of operating voltages higher than indicated in the specification may result in damage. Double check wiring connections



prior to powering the transmitter. Damage from incorrect wiring connections or from too much voltage applied is not covered under warranty.

All wiring should be run in EMT (or better) conduit properly earth grounded. Signal output and supply should be in shielded cable. The cable shield should be connected to earth ground at the controller/power supply that is providing power for the LPT-A-VLT-NH3-S.

### 6.6.1 Power Connection Supplied by Installer

If the installer is powering the LPT-A-VLT-NH3-S with four wire 24 VAC, the VAC wires should be connected to the terminal “one” (AC) and terminal “two” (AC / DC), from the top down. The signal return should be connected to terminal “three” (GND). The “signal” (4 - 20 mA or 0 - 10 volt) wire is always connected to terminal “four”.

## 4-Wire VAC

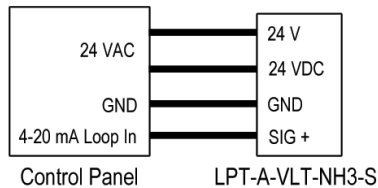

If the installer is powering the LPT-A-VLT-NH3-S with three wire 24 VDC or ground referenced AC, the “positive” wire should be connected to terminal “two” (AC / DC) and the negative wire should be connected to terminal “three” (GND). The “signal” (4 - 20 mA or 0 - 10 volt) wire is always connected to terminal “four”.

## 3-Wire VDC

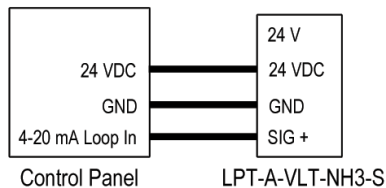

**NOTE: WARRANTY VOID IF SOLID-CORE WIRE IS USED AT THE WIRING TERMINAL STRIP.** When using solid core wiring for distribution (in the conduit), use stranded wire pigtails 18 AWG within the enclosure to connect to the circuit board. The rigidity of solid-core wire can pull a soldered terminal strip completely off a circuit board and this will not be covered under warranty.

**System power:** The main wiring terminal strip on the LPT-A-VLT-NH3-S circuit board can be unplugged for easier wiring installation. Grasp the two sides of the terminal strip and pull sideways.

### 6.6.2 Power Connection Supplied by QCC or FCS Controller

The QCC Controller provides 24 VDC (low voltage power) at the A1 through A4 connections on the Analog IN Terminal for connecting analog transmitters.

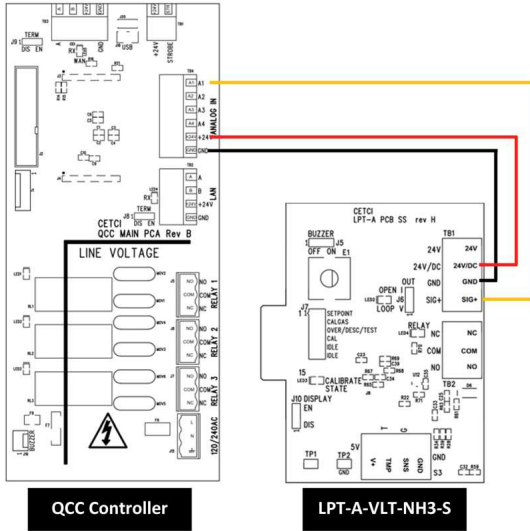

The FCS Controller provides 24 VDC (low voltage power) to the S1 through S4 connections on the Analog Input Terminal on the optional -AI board for connecting analog transmitters.

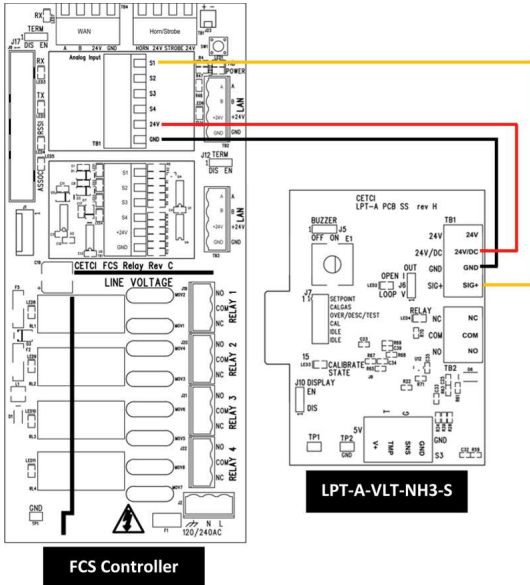

When connecting analog transmitters, the 24 VDC power supply and GND can be daisy-chained to the next transmitter. Each signal wire is connected directly from the Controller to each transmitter.

Three-conductor, 16-18 gauge wire / cable must be shielded when connecting to an analog transmitter.

The voltage supplied by the Controller to each analog transmitter should measure approximately 24 VDC nominal at the transmitter(s). If this voltage is not attained after installation, the wrong gauge wire may have been used or the wiring run is too long.

Common wire colours for positive, negative and signal VDC wires are:

- Red for positive
- Black for negative
- White or Yellow for signal

**NOTE:** DO NOT use solid-core wire for connection to wiring terminal strip. Any damage caused by using solid-core wire will void warranty. Use stranded wire ONLY. Under most local electrical codes, low voltage wires cannot be run within the same conduit as line voltage wires.

## 6.7 Relay Connection

The relay operates in “failsafe” mode, i.e. the relay coil is energized under normal non-alarm conditions. The relay is de-energized when the detected gas level is greater than or equal to the setpoint, or if power fails.

In most applications the relay function should use the common “COM” and normally closed “NC” terminals. With this wiring the connection will be open under normal, low gas concentration conditions. When the gas concentration rises (or if there is a power failure) the connection relay will close and signal the control panel or fan control.

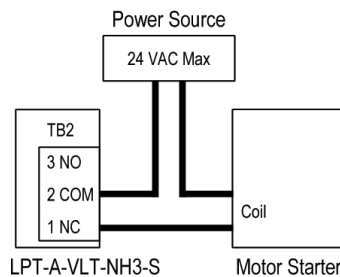

Example of an LPT-A-VLT-NH3-S connected to an RSH-24VDC Remote Strobe/Horn Combo on next page.

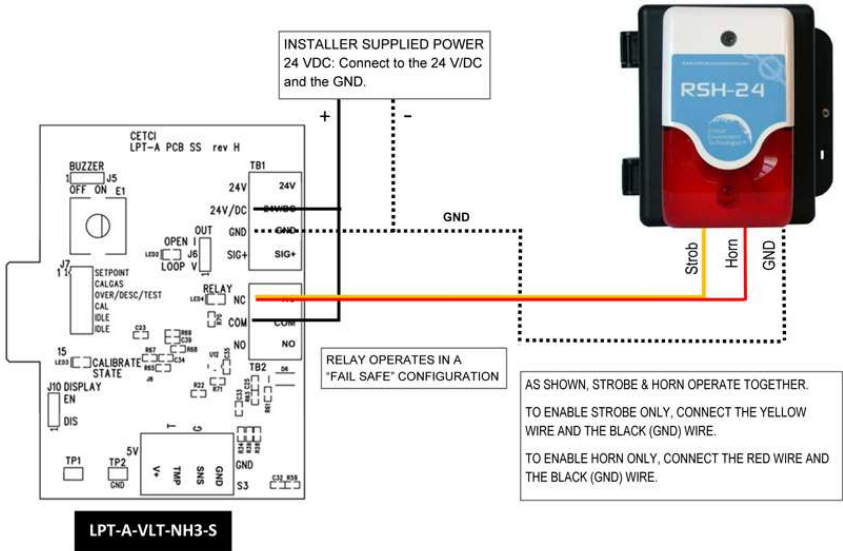

### 6.8 Wire Gauge vs Run Length

The table below shows the maximum cable length between the LPT-A-VLT-NH3-S and the Controller for normal installations (a separate cable from the Controller for each LPT-A-VLT-NH3-S).

SUPPLY VOLTAGE	MAXIMUM LOAD (Wire + Termination Resistor) (ohms)	WIRE GAUGE (awg)	MAXIMUM CABLE LENGTH (feet)
24 VDC		20	4,400
		18	7,100
		16	10,700
16 VDC	216 (assume a 200 Ω termination resistor)	20	700
		18	1,200
		16	1,800
24 VAC	1,060	20	27,000
		18	43,200
		16	65,500
12 VAC	316 (assume a 200 Ω termination resistor)	20	5,600
		18	8,900
		16	13,583

**NOTE:** The termination resistor could be as high as 500  $\Omega$  (10 volt measurement at 20 mA). A poor quality 24 VAC transformer might supply as little as 14 volts at low line conditions.

Upon application of power, the display will show the gas formula (NH<sub>3</sub>), the units of measurement (% vol) and a "WARM UP" message. During this warm-up period (approximately 3 minutes) the output signal is fixed at 4.0 mA (current) or 0 volt (voltage). After the warm up period, the system may exhibit gas alarm condition if the sensor has not completely stabilized during the warm up period. This is normal and the length of time the gas alarm exists is dependent upon the length of time since the unit was last powered up and the state of the environment it is installed in.

After warm up the display will show the current gas reading (if the display jumper is in the ENable position). If the display jumper is in the DISable position the display will continue to show the gas type (NH<sub>3</sub>), but will not display the units or gas reading.

## 6.9 Open Loop

If the 4 - 20 mA signal loop has not been connected properly or has been damaged in some manner between the analog transmitter and the device to which it is sending its signal output, the LPT-A-VLT-NH<sub>3</sub>-S will show an open loop icon OL at the bottom right of the display, as well as turning on the internal open loop LED. At this point, the wiring should be inspected for problems.

**NOTE:** If the voltage output is chosen, the open loop indicators will always be on.

## 7 SYSTEM OPERATION & CONFIGURATION

**NOTE:** The LPT-A-VLT-NH<sub>3</sub>-S can operate as part of a network or as a standalone gas detection device.

When part of a network, the LPT-A-VLT Ammonia Vent Line transmitter will continuously monitor gas concentrations on the configured channel and will send an analog signal back to the Controller, BAS, DDC or similar control panel. The Controller or control panel will interpret the signal as gas readings and it will trigger the safety responses (alarms, relays) as it has been configured.

If the LPT-A-VLT-NH<sub>3</sub>-S is being used as a standalone device, it will operate according to the gas readings, alarm setpoint, buzzer and relay configurations as outlined in this manual. In the event of a gas build up in excess of the alarm setpoint, the internal alarm will sound and the relay will be triggered to activate a remote horn and/or strobe device, ventilation fans and/or some other safety procedure. When the gas level drops below the configured alarm point, the device will return normal operation.

Normal operation is indicated by the display showing the gas reading or the gas formula. During normal operation, the gas level will be reported through the current loop (or voltage) output, and a rough reading can be obtained from the voltage test points.

### 7.1 Power Up and Warm-up

The current gas level reading can be monitored at any time during normal operation using the display. The display will be backlit when the menu is in active use.

Upon application of power, the device will enter the warm-up period and display a countdown of the time remaining before it is done warming up.

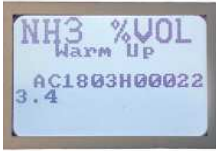

The warm up period is approximately 3 minutes. After the warm up period the device may exhibit gas alarm conditions if the sensor has not completely stabilized during the warm up period. This is normal and the length of time the gas alarm exists is dependent upon the length of time since the unit was last powered up and the state of the environment it is installed in. The transmitter may require a powered period of 24 to 48 hours for the sensor to stabilize before readings can be determined to be accurate.

## 7.2 Display Select

The normal display can be selected by moving the jumper at J10 from one position to the other.

J10 in ENable position (pins 2 - 3 connection): the display will be backlit and show the gas formula, the units and the current gas level. This is the factory default position.

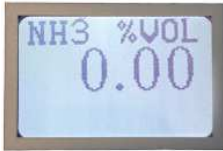

J10 in DISable position (pins 1 - 2 connected): the display will be backlit but will only show the name of the gas (it will not show the gas readings) and any abnormal conditions, e.g. fault, etc.



The display will always show messages during service functions, e.g. test, calibrate, etc.

## 7.3 Enable or Disable the Internal Buzzer / Audible Alarm

The LPT-A-VLT-NH3-S has an internal buzzer (alarm) that can be enabled or disabled. The buzzer is linked to the backlight of the display, so that in an alarm condition, the backlight of the display will flash on and off. The alarm, flashing display and relay will return to normal state when the gas level reading drops below the setpoint.

The factory default setting for the buzzer is ENabled. The buzzer can be DISabled by moving the jumper at J5 from the ON (pins 2 - 3 connected) to the OFF position (pins 1 - 2 connected).

## 7.4 Select the Output Signal

The default signal output mode is 4 - 20 mA current loop. Zero concentration gas will output 4 mA and full scale 3.00% vol / 30,000 ppm will output 20 mA.

The output can be changed to voltage (0 - 10 volt) by moving the jumper at J6 from the I position (pins 2 - 3 connected) to the V position (pins 1 - 2 connected). The voltage signal will swing from zero (0) volts to indicate no gas detected, to 10 volts to indicate full scale gas detected.

## 7.5 Fault Detection

The LPT-A-VLT-NH3S has built in fault detection. In the event of a problem with the measurement circuitry the transmitter will indicate a fault condition on the display. A dead or damaged catalytic sensor could go open circuit and create a fault indication or if the sensor has been poisoned, it could show as a zero gas reading. At this point, the transmitter will output 0 mA on the current loop (or 0 volts on the voltage output). Try recalibrating the device and if that fails, a new sensor may be required. Normal operation will resume once the fault condition has been rectified.



## 7.6 Test Functions

During warm up and normal operation, the signal output (current or voltage), the relay and the buzzer (if enabled) can be tested using the jumpers at J7.

### 7.6.1 Test Relay and Buzzer

With both jumpers on the IDLE position, place one on the OVER / DESC / TEST position. The relay should trigger immediately and the buzzer will sound (if enabled).

During the test the display will show the real world current gas readings and an icon indicating that the LPT-A-VLT-NH3-S is in the test mode.

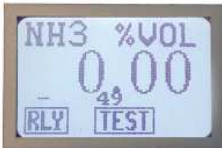

Return the jumper placed on the OVER / DESC / TEST location to an IDLE position when testing is complete. The unit will return to normal operation after 5 minutes if the jumper is not removed from the OVER / DESC / TEST position.

## 7.6.2 Test Voltage Output to Test Points TP1 - TP2

Attach a volt meter's leads to the two test points TP1 and TP2 located on the lower left corner on the back of the circuit board. Set the meter to volts DC with one decimal point. The range of 0 - 4.0 VDC is equal to the full measurement range of the sensor. The ammonia sensor range is 0 - 3.00% or 0 - 30,000 ppm, therefore 2.0 VDC = 1.5% vol or 15,000 ppm and 4.0 VDC = 3.00% vol or 30,000 ppm.

## 7.7 Relay Operation / Set the Alarm Setpoint

The alarm level is the gas concentration at and above which the device will acknowledge a high gas level and will trip the relay, the buzzer will sound (if enabled) and the display (if enabled) will indicate an alarm condition.

The factory default setpoint is 0.5% vol (5,000 ppm).

If the setpoint needs to be changed, it can be done by:

- Moving a jumper from one of the IDLE positions to the SETPOINT position
- Rotate the shaft of the encoder, E1, clockwise to increase the setpoint or counter-clockwise to decrease the set point,
- The setpoint will be displayed, along with a "SETPOINT" icon indicating that the setpoint is being changed



- After the setpoint is changed as desired, move the jumper from the SETPOINT position back to the IDLE position.

The setpoint can also be monitored with a volt meter connected between TP1 and TP2. The value will be a 0 - 4 volt signal proportional to the setpoint level.

To relate the voltage to a setpoint level use the following equation:

$$[\text{Voltage Reading} / 4 \text{ V}] \times [\text{Sensor Full Scale Range}] = \text{Gas Reading}$$

or

$$[\text{Gas Reading} / \text{Sensor Full Scale Range}] \times [4 \text{ V}] = \text{Voltage Reading}$$

For example, an ammonia sensor with a full scale range of 3.0% vol (30,000 ppm) and a test point voltage reading of 0.66 volts, the gas level would be  $[0.66 \text{ V} / 4 \text{ V}] \times [3.0\% \text{ vol}] = 0.5\% \text{ vol}$

SENSOR GAS TYPE	TRIP POINT (ALARM LEVEL)	TP1 - TP2 VOLTAGE
Ammonia	0.5% vol / 5,000 ppm	0.66 volts



If there is no activity (i.e. turning the encoder shaft) for 5 minutes, the LPT-A-VLT-NH3-S will return to normal mode. After returning to normal mode the jumper will have to be moved from the SETPOINT position to the IDLE position and then re-installed at the SETPOINT position if further adjustment is needed.

## 8 CALIBRATION

### 8.1 Calibration Specifications

#### 8.1.1 Gas

Calibration span gases should have at least  $\pm 5\%$  accuracy and have a current date stamp. Gas generators should have a current dated cell installed. It is important to note that the type of gas mixture, how old the gas is and what temperature it has been stored at will also affect repeatability during field calibration.

Every LPT-A-VLT Ammonia Vent Line transmitter is calibrated in a chamber by true diffusion method prior to leaving our facility. This method more closely emulates actual "real world" conditions. Field calibration using gas cylinder, regulator and hose directing span gas into the sensor may result in slightly higher readings.

**NOTE:** Catalytic sensors require oxygen to work and thus the user **MUST** expose the sensor to clean air or flow oxygen to obtain a true zero. In addition, calibration / span gas must have "air" balance, not Nitrogen ( $N_2$ ) balance.

#### 8.1.2 Regulators & Flow

Ammonia is lighter than air so the calibration gas should be flowed at 0.5 LPM. Fixed flow regulators provide more accuracy.

#### 8.1.3 Adapters

The grey calibration adapter with an O-ring and two zeroing port plugs (P/N: CET-7000-CAP) is required to calibrate the LPT-A-VLT Ammonia Vent Line transmitter. Ensure it is pressed firmly over the potted sensor so it allows the gas to properly diffuse around the sensor.

#### 8.1.4 Calibration Frequency

- Occupational Health & Safety (OHS) applications: once every 6 months
- For best performance and to meet published specifications: once every six months

**NOTE:** A calibration label should be applied after every calibration to confirm work performed and the date it was completed. If a controller is involved, the alarm set points should be indicated on a label on the front door of the enclosure so anyone working in the environment can be aware.

Equipment: Calibration Kit, calibration gases, digital multi-meter, magnetic wand, cylinder of  $NH_3$

Users can order the Calibration Kit, calibration accessories and / or gases from any CETCI authorized distributor or you can supply your own gas and equipment as long as the gas meets the minimum specifications. **NOTE:** CETCI cannot ship gas cylinders outside of Canada.

### 8.1.5 Gas Testing Frequency - Bump Testing

For the purpose of safety in OHS applications, sensors should be bump tested once every month to confirm response and alarm activation. To make the process easier, install a capped T-pipe between the vent stack and the coupler of the LPT-A-VLT Ammonia Vent Line transmitter. To bump test, simply remove the cap, place the calibration adapter plug into the pipe and flow 5,000 ppm of ammonia. Otherwise, the transmitter must be removed from the vent stack (same as calibration) in order to bump test the sensor.

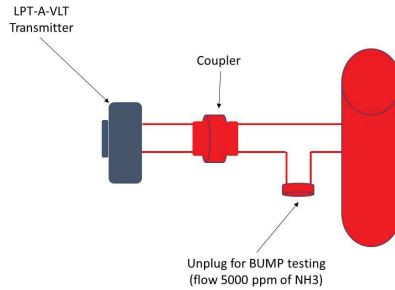

### 8.1.6 Non-Intrusive Calibration

Calibration can usually be performed without opening the transmitter by using the magnetic wand (P/N: **CET-MW**) is available from CETCI. It is used to touch the enclosure at the lower left edge near the splash guard. Refer to Section 5.1 *Exterior Enclosure - Front* for the location. A second touch with the calibration wand can be used to cancel the current calibration step.

The LPT-A-VLT-NH3-S will need to be opened for calibration when any of the following conditions occur:

- The transmitter has not been calibrated for an extended period, which has allowed the sensor aging to reach a level that there appears to be an ambient gas level higher than the transmitter is allowed to correct for.
- The calibration gas concentration to be used is different from that previously set.
- The ambient gas level is higher than considered reasonable. CETCI strongly recommends using zero air.

## 8.2 Calibration Procedure

The ammonia sensor is potted into a 5 cm / 2 in long pipe fitting that protrudes from the back of the enclosure.

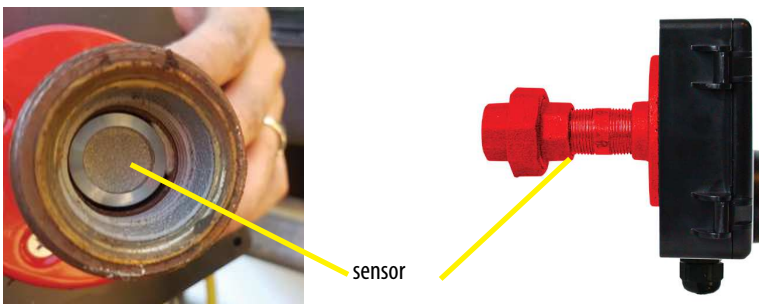

The pipe is then connected with a coupler to a mounting pipe on the vent stack to secure the device in place. The transmitter must be removed from the vent stack in order to calibrate the sensor.

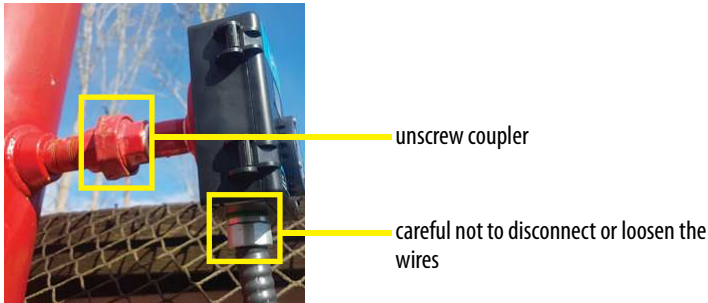

Unscrew the wide ring portion of the coupler and carefully remove the device from the mounting pipe. Be careful to not handle the device roughly resulting in disconnecting or loosening the wires.

**WARNING:** When you remove the device, the vent stack will be exposed and ammonia may leak into the air. Vent line systems should always be treated with extreme caution and workers should assume a relief valve could release at any time. Take all necessary safety precautions and follow industry standard practices and local regulations when calibrating the LPT-A-VLT-NH3-S.

Press the calibration adapter with an O-ring and two zeroing port plugs into the sensor opening with the tubing attached.



(P/N: CET-7000-CAP)

**NOTE:** Ammonia is a reactive gas and can adhere to surfaces which can reduce the amount of gas that reaches the sensor. When calibrating an ammonia sensor use a length of tubing no longer than 0.6 to 1 m / 2 to 3 ft. If a longer length is necessary, use Teflon lined tubing to ensure the correct concentration of gas reaches the sensor.

The calibration procedure of the LPT-A-VLT-NH3-S is jumper automated (there are no potentiometers to adjust). Monitoring the calibration with a volt meter at TP1 and TP2 is optional.

The range of 0 - 4.0 VDC is equal to the full measurement range of the sensor. The ammonia sensor in the LPT-A-VLT-NH3-S has a standard measurement range of 0 - 3.00% vol or 0 - 30,000 ppm. Therefore, 4.0 VDC = 30,000 ppm.

To complete calibration, the user must go through the following steps:

- Disconnect the LPT-A-VLT-NH3-S from the mounting pipe by unscrewing the coupler.
- Prepare the cylinder of NH<sub>3</sub> by attaching the tubing connected to the calibration adapter plug to the regulator to the cylinder.

### STEP 1: SET CALIBRATION GAS LEVEL

Proceed to STEP 2 if you know you are using the same calibration gas concentration as was used during the previous calibration.

The factory default calibration gas concentration is:

Sensor Gas Type	Calibration Gas Level	TP1 - TP2 voltage
Ammonia (NH3)	0.5% (5,000 ppm)	0.66 volt

If you are using a different calibration gas concentration (or you don't know what concentration was used) for the previous calibration, you will need to set the calibration gas level and if using a volt meter, determine the voltage equivalence.

The formula for determining the TP1 - TP2 voltage equivalence is:

$$\text{(Cal Gas Concentration / Sensor Range)} \times 4$$

For example:  $(5,000 / 30,000) \times 4 = 0.666$  volts

To set the calibration gas level:

- Move one jumper from an IDLE position to the CALGAS position.
- Rotate the encoder, (E1) to increase or decrease the calibration gas value as required. For example, if using 0.5% cal gas, the setting should be 0.50 and if using a 1% cal gas, the setting should be 1.0.



- While adjusting the calibration gas value a corresponding voltage will be signaled on the test points TP1 and TP2. For example, if using a calibration gas of 5,000 ppm, the test points should indicate 0.66 volts. If using a calibration gas concentration of 10,000 (1% vol), the test points should indicate 1.33 volts.
- After changing the calibration gas level to the appropriate concentration, move the jumper from the CALGAS position back to the IDLE position.
- If the encoder is not rotated within 5 minutes the transmitter will automatically return to normal operation. The jumper will have to be removed and re-installed at the CALGAS position if further adjustment is required.

## STEP 2: EXPOSE TO CLEAN AIR

- Let the device rest for 2 minutes after disconnecting it from the mounting pipe and before using ambient air or a cylinder of zero air to zero the device.

## STEP 3: TRIGGER THE CALIBRATION

- Move one jumper from the IDLE position to the CAL position. Or, if using the magnetic wand, touch the enclosure of the LPT-A-VLT-NH3-S with the wand (below and just to the left of the splash guard on the front of the enclosure).



The LPT-A-VLT-NH3-S will use the last four seconds of gas data to determine the zero calibration level.

Depending on the reading the LPT-A-VLT-NH3-S will show one of the following messages:

- ZERO ACCEPTED - proceed to STEP 5



- ZERO OUT OF RANGE, OVERRIDE? - proceed to STEP 4

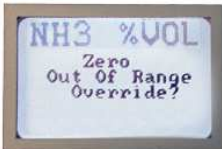

- ZERO FAILED! RECALIBRATE - see Fault Detection at end of these calibration instructions

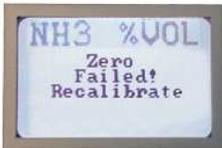

## STEP 4: OVERRIDE

- If the zero level appears too high (the ambient air might have a slight background of the target gas present, or it might have been so long since the last calibration that the sensor has drifted), the display will show "ZERO OUT OF RANGE, OVERRIDE?" and the internal Calibrate State LED will flash with a short OFF time and long ON time.

- To Override, leave the one jumper on the CAL position and move the second jumper from IDLE to the OVER / DESC / TEST position.
- If the jumper is not moved to the OVER position within 30 seconds, the calibration will be cancelled and the LPT-A-VLT-NH3-S will return to normal mode.
- If Override is accepted - Proceed to STEP 5. If the Override is not accepted, you can exit calibration and try zeroing the device again. If it still doesn't work, the sensor should be replaced.

**NOTE: Any time during STEPS 5 through 7, move the jumper from the OVER / DESC / TEST position back to the IDLE position.** This should be done before the span gas reading is established (before STEP 8 is completed).

### STEP 5: ZERO ACCEPTED

- Once zeroed (or override is accepted), the display will show 'FLOW GAS' and the internal calibrate state LED will flash four times and then paused with the LED off.

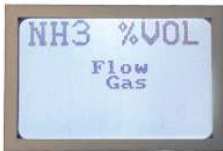

### STEP 6: ATTACH SPAN GAS

- Place the calibration plug adapter with the tubing attached over the sensor opening in the pipe and press firmly to secure it in place.
- If you have not done this already, attach the cylinder of NH<sub>3</sub> calibration gas to the tubing connected to the calibration plug adapter.

### STEP 7: FLOW SPAN GAS

- Open regulator valve fully and allow span gas to flow over the sensor.
- If no gas is detected after one minute, the transmitter will return to normal operation and the procedure will need to be repeated from STEP 2.

**NOTE:** If an inappropriate concentration of span gas is applied during calibration, calibration may succeed but it does not mean the equipment has been calibrated properly. CETCI is not responsible for improperly calibrated transmitters.

## STEP 8: WAIT FOR STABLE READING

- Once gas flow is detected, the display will show 'WAITING FOR STABLE READING':

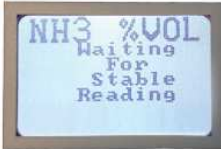

- The calibrate state LED pattern will flash four times and then pause with the LED on. During this time the TP1 voltage will follow the gas level based on the ideal span of the sensor.
- Spanning can be cancelled by removing the jumper from the CAL position and returning it to the IDLE position. Doing this will not cancel the zero value set in STEP 5.
- If spanning times out without an acceptable value, the display will show 'SPAN FAILED! RECALIBRATE'. The 4-20 mA output will signal the failure with 0 mA (0-10 volt will be 0 volt). This condition can only be resolved by a successful calibration.

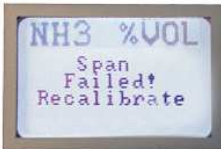

## STEP 9: SPAN COMPLETED

- After the span has completed successfully, the transmitter will display 'CALIBRATION COMPLETE' for several seconds, then return to normal operation. Make sure both jumpers are returned to the IDLE positions.

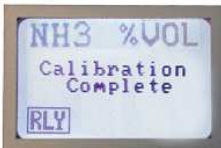

- If the calculated sensitivity of the sensor is out of range the display will show 'SPAN FAILED! RECALIBRATE' indicating the sensor cannot be calibrated. You can try recalibrating, starting from STEP 2, to confirm the procedure was followed correctly and this may correct the fault.
- If the span fails repeatedly the sensor has either aged beyond its useful life or has otherwise failed, please contact our service department at [service@cetci.com](mailto:service@cetci.com).

**NOTE:** The LPT-A-VLT-NH3-S will automatically return to normal operation after a successful calibration. If the calibration gas is still applied the level will be reflected on the output signal and relay, which could cause a control panel to enter an alarm state. If the span calibration was not successful the LPT-A-VLT-NH3-S will display 'CALIBRATION FAILED! RECALIBRATE' and output 0 mA (0 volts) until a successful calibration is performed.

### 8.3 Exit Calibration

To exit calibration at any time, either:

- Return both jumpers to the IDLE positions. Or touch the enclosure with the magnetic wand a second time.

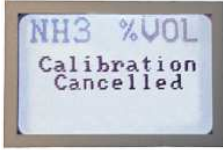

NOTE: A full calibration should be conducted every six months and bump tests should be done monthly; unless a significant exposure incident occurs, after which additional bump tests and/or calibrations are required to ensure the device is working properly and the sensor has not been poisoned.

### 8.4 Sensor Replacement

p/n: **VLT-NH3-SEN**

The catalytic ammonia sensor has a lifespan of approximately 2 to 3 years under normal air conditions. The sensor may need replacing sooner if it is poisoned by exposure to a very high concentration of ammonia and/or prolonged exposure to high concentrations. The replacement sensor comes potted in a 2" pipe with the wires attached. Unscrew the old sensor pipe from the back of the transmitter and disconnect the wires from the Remote Sensor Terminal block. Replace with the new assembly.



## 9 ACCESSORIES

### 9.1 Magnetic Wand p/n: **CET-MW**

The magnetic wand is used for non-intrusive calibration (without opening the enclosure), using the magnetic sensor on the front of the enclosure located to the lower left edge of the splash guard.



Lifts	226.7 g (½ lb) solid steel
Size	66.6 mm x 6.35 mm (2 5/8" X 1/4") Hexagon

### 9.2 Metal Protective Guard p/n: **SCS-8000-RSG**

The metal protective guard is made of heavy gauge, galvanized metal and helps protect against abrasive damage, theft and vandalism to the transmitters. The 16-gauge galvanized steel has 13 mm / ½ in square openings in the front to allow gas and air to flow through to the sensor. With only four slotted mounting holes, installation and removal for gas detector servicing is easy.





Enclosure	16 gauge galvanized steel
Weight	800 g (28 oz)
Size	178 mm W x 160 mm H x 91 mm D (7.0 in W x 6.3 in H x 3.6 in D)

### 9.3 Calibration Kit p/n: CET-715A-CK1

The Calibration Kit contains the items necessary for common field and shop calibration of all gas detection models (new and old) manufactured by CETCI. It comes in a durable, hard plastic carrying case.

**Gas cylinders are not included in the Kit.** They must be ordered separately from the CETCI factory. Many gases are carried in inventory but not all. Check with any CETCI authorized distributor for availability of specific gas types. **Gas cylinders cannot be shipped from Canada to other countries, including the USA.** For more information check out our website <http://www.critical-environment.com/products/calibration-kit.html>



## 10 MAINTENANCE

The LPT-A-VLT-NH3-S transmitter requires virtually no maintenance other than regular calibration of the sensor. There are no replaceable components except the sensors.

The transmitter should be regularly inspected and monitored for possible damaging conditions.

- The sensor vent should be kept free of dirt and debris build up.
- If in a damp location, source of water should be shielded from continually contacting the top of the transmitter.
- If located in a working area, the front of the transmitter should be kept clear.

- If painting is to be conducted in the transmitter's location the transmitter needs to be protected from over spray and the sensor port should not receive paint fumes – these fumes may damage or reduce the life of the sensor.
- If mounted outside in very cold temperatures ( $> -20^{\circ}\text{C} / -4^{\circ}\text{F}$ ), encasing the transmitter in a suitable insulated box may be necessary.
- It is important to ensure that excess water and/or dust is not somehow entering the enclosure and physically damaging the circuit board or internal components.

## 11 TROUBLE SHOOTING

### **LPT-A-VLT-NH3-S won't power up. (blank display)**

Is the power properly connected? Check the connections. Refer to Section 6.6 *Wiring Power Connections*.

### **Display shows a fault message and the current loop outputs 0 mA.**

The LPT-A-VLT-NH3-S is in fault mode. If re-calibrating the sensor fails, replace the transmitter.

### **During calibration the display shows "override" message.**

The sensor needs an override. Move the second IDLE jumper to the OVER / DESC / TEST position.

### **Display shows "Span Failed. Recalibrate".**

The span calibration failed. Try to recalibrate the sensor again.

### **LPT-A-VLT-NH3-S powered up (display appears normal) but the control panel displays "Fault".**

4 - 20 mA signal loop has not been connected properly. Check the connections. Refer to Section 6.6 *Wiring Power Connections*.

### **List of Possible LPT-A-VLT-NH3-S Error Codes:**

(appears on the display with a triangle that has an ! in the center of it)

Code	Description
001	Negative Sensor The sensor signal is too far negative. May be caused by a sensor that is temperature or humidity sensitive. Zeroing the sensor will normally resolve this.
002	High Sensor The sensor signal is too high (above the defined range for the LPT-A-VLT-NH3-S). May be caused by using a calibration gas with a concentration that doesn't match the setting in the LPT-A-VLT-NH3-S.
003	AFE chip has failed Internal chip AFE has failed. If a power cycle does not resolve this, then the LPT-A-VLT-NH3-S must be replaced.
004	POT chip has failed The internal chip POT has failed. If a power cycle does not resolve this, then the LPT-A-VLT-NH3-S must be replaced.
005	DAC chip has failed The internal chip DAC has failed. If a power cycle does not resolve this, then the LPT-A-VLT-NH3-S must be replaced.





**Critical Environment Technologies Canada Inc.**

Unit 145, 7391 Vantage Way, Delta, BC, V4G 1M3, Canada

Toll Free: +1.877.940.8741

Tel: +1.604.940.8741

Fax: +1.604.940.8745

[www.critical-environment.com](http://www.critical-environment.com)