



Rev. B | 2017.05

QCC-RDM

 Remote Display Transmitter

TABLE OF CONTENTS

1 POLICIES	4
1.1 Important Note	4
1.2 Warranty Policy	5
1.3 Service Policy	5
1.4 Copyrights and Registered Trademarks	6
1.5 Disclaimer	6
1.6 Revisions	7
2 INTRODUCTION	8
2.1 General Description	8
2.2 Key Features	8
3 INSTRUMENT SPECIFICATIONS	9
3.1 Technical Specifications	9
3.2 Enclosure Dimensions	12
4 INSTRUMENT FEATURES	13
4.1 Exterior Enclosure	13
4.2 Interior System Layout	14
5 INSTALLATION	15
5.1 General Safety Warnings	15
5.2 Protection Against Electrical Risks	15
5.3 Protection Against Mechanical Risks	16
5.4 Enclosure Mounting Components	17
5.4.1 Enclosure Interior Base	17
5.4.2 Enclosure Bottom	18
5.5 Wiring Power Connections	18

5.6 Wiring the QCC-RDM to the QCC or FCS.....	19
5.6.1 Wiring Connection for the QCC and QCC-RDM.....	20
5.6.2 Wiring Connection for the FCS and QCC-RDM	20
6 SYSTEM OPERATION & CONFIGURATION.....	21
6.1 Navigating the Menu Structure.....	21
6.2 Accessing the Menu with Passcodes.....	21
6.3 Power Up and Warm-up.....	22
6.4 Normal Display.....	23
6.5 Set LCD Display Contrast Level.....	25
6.6 Mask Channels.....	25
6.7 Modbus® Settings	26
6.7.1 Change Modbus® ID	27
6.7.2 Set Baud Rate.....	28
7 MAINTENANCE.....	29
8 TROUBLE SHOOTING.....	29

1 POLICIES

1.1 Important Note

Read and understand this manual prior to using this instrument. Carefully read the warranty policy, service policy, notices, disclaimers and revisions on the following pages.

This product must be installed by a qualified electrician or factory trained technician and according to instructions indicated in this manual.

This instrument has not been designed to be intrinsically safe. For your safety, **do not** use it in classified hazardous areas (explosion-rated environments).

INSTRUMENT SERIAL NUMBER:

PURCHASE DATE:

PURCHASED FROM:

1.2 Warranty Policy

Critical Environment Technologies Canada Inc. (CETCI), also referred to as the manufacturer, warrants this instrument, (excluding sensors, battery packs, batteries, pumps and filters) to be free from defects in materials and workmanship for a period of **two years from the date of purchase from our facility**. If the product should become defective within this warranty period, we will repair or replace it at our discretion.

The warranty status may be affected if the instrument has not been used and maintained per the instructions in this manual or has been abused, damaged, or modified in any way. This instrument is only to be used for purposes stated herein. The manufacturer is not liable for auxiliary interfaced equipment or consequential damage.

Due to ongoing research, development, and product testing, the manufacturer reserves the right to change specifications without notice. The information contained herein is based on data considered accurate. However, no warranty is expressed or implied regarding the accuracy of this data.

All goods must be shipped to the manufacturer by prepaid freight. All returned goods must be pre-authorized by obtaining a Returned Merchandise Authorization (RMA) number. Contact the manufacturer for a number and procedures required for product transport.

1.3 Service Policy

CETCI maintains an instrument service facility at the factory. Some CETCI distributors / agents may also have repair facilities; however, CETCI assumes no liability for service performed by anyone other than CETCI personnel.

Repairs are warranted for 90 days after date of shipment (sensors have individual warranties). Should your instrument require non-warranty repair, you may contact the distributor from whom it was purchased or you may contact CETCI directly.

Prior to shipping equipment to CETCI, contact our office for an RMA #. All returned goods must be accompanied with an RMA number.

If CETCI is to do the repair work, you may send the instrument, prepaid, to:

Attention: Service Department
Critical Environment Technologies Canada Inc.
Unit 145, 7391 Vantage Way
Delta, BC, V4G 1M3

Always include your Returned Merchandise Authorization (RMA) number, address, telephone number, contact name, shipping / billing information, and a description of the defect as you perceive it. Pack the equipment well (in its original packing if possible), as we cannot be held responsible for any damage incurred during shipping to our facility. You will be contacted with a cost estimate for expected repairs, prior to the performance of any service work.

For liability reasons, CETCI has a policy of performing all needed repairs to restore the instrument to full operating condition.

1.4 Copyrights and Registered Trademarks

This manual is subject to copyright protection; all rights are reserved. Under international and domestic copyright laws, this manual may not be copied or translated, in whole or in part, in any manner or format, without the written permission of CETCI.

Modbus® is a registered trademark of Gould Inc. Corporation.

1.5 Disclaimer

Under no circumstances will CETCI be liable for any claims, losses or damages resulting from or arising out of the repair or modification of this equipment by a party other than CETCI service

technicians, or by operation or use of the equipment other than in accordance with the printed instructions contained within this manual or if the equipment has been improperly maintained or subjected to neglect or accident. Any of the forgoing will void the warranty.

Under most local electrical codes, low voltage wires cannot be run within the same conduit as line voltage wires. It is CETCI policy that all wiring of our products meet this requirement.

It is CETCI policy that all wiring be within properly grounded (earth or safety) conduit.

1.6 Revisions

This manual was written and published by CETCI. The manufacturer makes no warranty or representation, expressed or implied including any warranty of merchantability or fitness for purpose, with respect to this manual.

All information contained in this manual is believed to be true and accurate at the time of printing. However, as part of its continuing efforts to improve its products and their documentation, the manufacturer reserves the right to make changes at any time without notice. Revised copies of this manual can be obtained by contacting CETCI or visiting www.critical-environment.com. Should you detect any error or omission in this manual, please contact CETCI at the following address:

Critical Environment Technologies Canada Inc.
Unit 145, 7391 Vantage Way, Delta, BC, V4G 1M3, Canada
Toll Free: +1.877.940.8741
Telephone: +1.604.940.8741
Fax: +1.604.940.8745
Email: marketing@cetci.com
Website: www.critical-environment.com

In no event will CETCI, its officers or employees be liable for any direct, special, incidental or consequential damages resulting from any defect in any manual, even if advised of the possibility of such damages.

2 INTRODUCTION

2.1 General Description

Thank you for purchasing our QCC-RDM Remote Display. The QCC-RDM Remote Display is designed to connect to the QCC Quad Channel Controller or the FCS Flexible Control System to provide convenient viewing of gas readings and system statuses in an alternate and relevant location to the controller; such as a refrigeration application where there are two different entrances to the chiller room.

The QCC-RDM will display much of the same information as the QCC or FSC, such as gas level readings, channel status and faults.

2.2 Key Features

- 4-lines, 20 character LCD display and LED indicators for alarm STATUS 1, 2, 3 and Fault conditions
- Internal audible alarm
- Modbus® RS-485 RTU communication
- Output for remote strobe and/or horn connection
- Connection loss detection to ensure accurate information is displayed

3 INSTRUMENT SPECIFICATIONS

3.1 Technical Specifications

MECHANICAL

Enclosure	ABS / Polycarbonate, rated UL94-5VA, designed to meet IP54 standards. Copper coated interior to reduce RF interference.
Weight	272 g (9.6 oz)
Size	127 mm x 127 mm x 71 mm (5.0 in x 5.0 in x 2.8 in)

ELECTRICAL

Power Requirement	0.5 W of power using the 24 VDC supplied by the controller
Current Draw	20.8 mA
Wiring	4-wire shielded network wiring between the controller and QCC-RDM
Communication: Modbus® RTU over RS-485	Baud rate: 19,200 (default) Modbus® ID: 230 (default) Modbus® Broadcast ID: 253 (default) Data bits: 8 Start bits: 1 Stop bits: 1 Parity: none
Fuses	Automatic resetting thermal

USER INTERFACE

Display	4-line, 20 character LCD display and LED indicators for "STATUS 1, 2 and 3", "FAULT" Configurable contrast (default is 20)
Indicator	Status LED indicators for low, mid, high and fault alarms
Menu	Accessed using up, down and enter push buttons

INPUT/OUTPUT

Communication	Receives Modbus® commands from QCC or FCS and duplicates the much of the display information
Outputs	One drive output for a 24V, max 500 mA remote strobe/horn
Audible Alarm	Internal buzzer

ENVIRONMENTAL

Operating Temperature	-20°C to 40°C (-4°F to 104°F)
Operating Humidity	15 - 90% RH non-condensing

CERTIFICATION

Model: QCC-RDM

S/N: QRDM1603B00001

Rating: 24 VDC, 0.5W, Class 2



CERTIFIED FOR ELECTRIC SHOCK & ELECTRICAL FIRE HAZARD ONLY. LA CERTIFICATION ACNOR COUVRE UNIQUEMENT LES RISQUES DE CHOC ELECTRIQUE ET D'INCENDIE D'ORIGINE ELECTRIQUE.

Conforms to: CSA-C22.2 No. 205-12, UL508 (Edition 17):2007

Conforms to: EMC Directive 2004/108/EC, EN 50270:2006, Type 1, EN61010

Conforms to: FCC. This device complies with part 15 of the FCC Rules, Operation is subject to the following two conditions: (1) This device may not cause harmful interference, and (2) this device must accept any interference received, including interference that may cause undesired operation.

3.2 Enclosure Dimensions

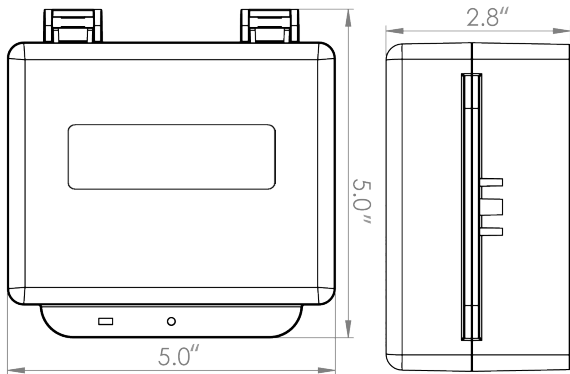

4 INSTRUMENT FEATURES

4.1 Exterior Enclosure



NUMBER	FEATURE	FUNCTION
1	Door Hinge	Secures door.
2	Display	4 lines x 20 characters.
3	Status 1, 2, 3 LEDs	Indicates channel alarm status.
4	ARROW UP	Press to scroll up through menu.

5	ENTER	Press to select menu choice.
6	ARROW DOWN	Press to scroll down through menu.
7	Fault LED	Indicates unit fault condition.
8	Door Screw	Secures the door of the enclosure.

4.2 Interior System Layout

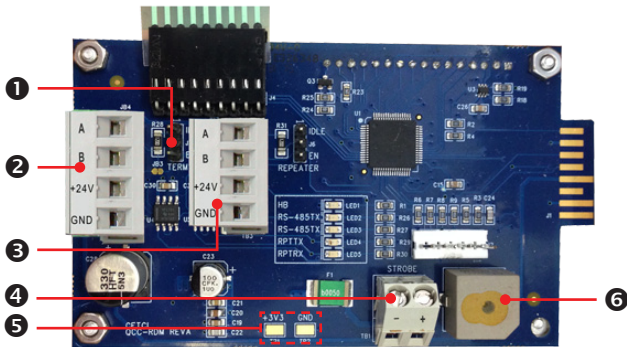

NUMBER	FEATURE	FUNCTION
--------	---------	----------

1	Jumper Bank (J5)	Termination resistor. If this device is the last one in the network chain, a termination resistor should be connected by placing a jumper in the EN position
----------	------------------	--

2	Modbus [®] Connector (TB2)	Terminal used to connect to the QCC-RDM to the QCC or FCS
3	Modbus [®] Connector (TB3)	Terminal used to connect other devices in the Modbus [®] network
4	Remote Strobe Terminal (TB1)	Connection for remote strobe or strobe/horn 24V 500 mA max.
5	Test Points: TP1 & TP2	Used for measuring voltage output
6	Buzzer	Internal audible alarm

5 INSTALLATION

5.1 General Safety Warnings

The QCC-RDM Remote Display is intended for indoor use, permanently mounted at a height that is appropriate for viewing, outside an area that requires a visual inspection of gas readings inside, prior to entry. The QCC-RDM should be protected from extreme weather conditions.

The QCC-RDM requires no assembly and virtually no maintenance. There are no serviceable elements or replaceable components.

5.2 Protection Against Electrical Risks

The QCC-RDM Remote Display is designed to be powered by the QCC or the FCS. Disconnect all power to all network devices before servicing. There may be multiple power sources. Power supply may have a building installed circuit breaker / switch that is suitably located and easy to access

when servicing is required. Appropriate markings should be visible at the circuit breaker / switch that is supplying power to controller.

This device may interfere with pacemakers. Modern pacemakers have built-in features to protect them from most types of interference produced by other electrical devices you might encounter in your daily routine. If you have a pacemaker, follow your healthcare provider's instructions about being around this type of equipment.

5.3 Protection Against Mechanical Risks

The door of the enclosure can be removed if absolutely necessary to facilitate installation of the base but it is not recommended on this version. Extreme care and caution must be exercised when removing the door to avoid damaging the hinges. The door should only be removed when absolutely required. Any damage occurring from door removal procedure will not be covered under warranty.

Simply grasp the door with one hand, being careful not to make contact with any of the internal components (circuit board), grasp the base with your other hand. Tug on the base and pull straight apart. **DO NOT TWIST.** The section of the hinges located on the base should “snap” apart from the part of the hinges located on the door.

After installation, simply locate the lid hinges over the installed base hinges and pull toward you. The hinges should easily “snap” back into place.

The enclosure has one screw securing the door to the base for electrical safety and provides an opening to allow the user to apply a padlock or tie wrap if they desire the transmitter to be locked. Refer to Section 4.1 *Exterior Enclosure*.

Be aware that the hinged door that could potentially pinch fingers and the sharp edges and/or jumper pins on the board could potentially prick or cut fingers if not handled carefully.

5.4 Enclosure Mounting Components

5.4.1 Enclosure Base

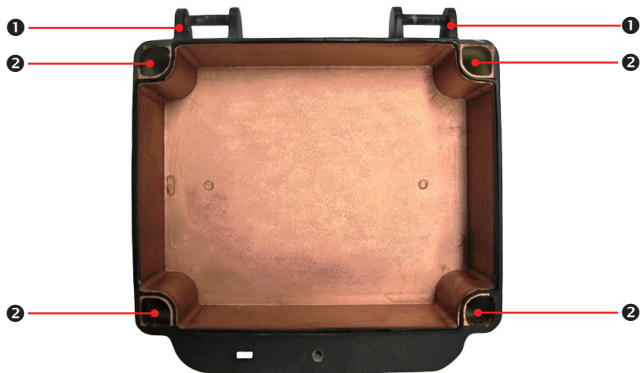

NUMBER	FEATURE
1	Door Hinge
2	Mounting Holes

5.4.2 Enclosure Side

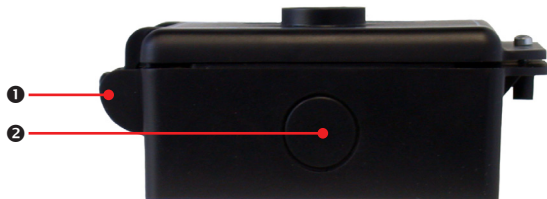

NUMBER	FEATURE
①	Door Hinge
②	1/2" Conduit Entry Knockout

5.5 Wiring Power Connections

The QCC-RDM Remote Display is a low voltage powered device. Any application of operating voltages higher than indicated in the specification may result in damage.

Double check wiring connections prior to powering the transmitter. Damage from incorrect wiring connections or from too much voltage applied is not covered under warranty.

External power to the QCC-RDM must be supplied by a 24 VDC power supply or a Class 2 (or better) transformer and connected to the Modbus® wiring terminal. The wiring should be 4-conductor shielded 16 awg stranded within conduit in a network wiring (daisy-chain) configuration.

Common wire colours for positive, negative and digital wires are:

- Red for positive
- Black for negative

- White for Data A
- Green for Data B

All wiring should be run within properly grounded (earth or safety) conduit. Signal output and supply should be in shielded cable. The cable shield should be connected to earth ground at the controller/power supply that is providing power for the QCC-RDM.

NOTE: WARRANTY VOID IF SOLID-CORE WIRE IS USED AT THE WIRING TERMINAL STRIP.

When using solid core wiring for distribution (in the conduit), use stranded wire pigtails 18 AWG within the enclosure to connect to the circuit board. The rigidity of solid-core wire can pull a soldered terminal strip completely off a circuit board and this will not be covered under warranty.

5.6 Wiring the QCC-RDM to the QCC or FCS

The QCC-RDM can be connected to the QCC or the FCS using the Modbus® LAN terminal connection. The read and write default QCC-RDM Modbus® ID is 230. The QCC-RDM will automatically broadcast the display information to Modbus® ID 253. This is the common Modbus® ID for all QCC-RDMs on the network and is used to listen for broadcasts from the controller and receive screen updates from the controller.

Once the QCC-RDM Remote Display is wired to the QCC or the FCS, the controller needs to be told that the QCC-RDM exists as a remote device. This is done at the controller. Refer to the *QCC Operation Manual* or the *FCS Operation Manual* for instructions.

Similarly, in order for the controller to communicate with the QCC-RDM, the two devices must have the same baud rate. The factory default baud rate for all CETCI Modbus® devices is 19,200. If you need to change the baud rate, refer to Section 6.7 *Modbus® Settings* for instructions on how to set the Remote Baud rate.

24VDC power is supplied to the QCC-RDM from the QCC or the FCS. Four-conductor, 16-18 gauge wire / cable must be shielded when connecting the controller to the QCC-RDM.

5.6.1 Wiring Connection for QCC and QCC-RDM

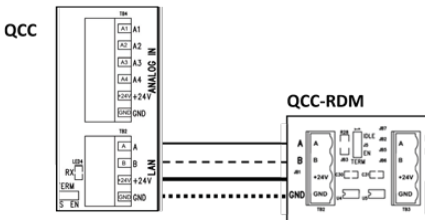

5.6.1 Wiring Connection for FCS and QCC-RDM

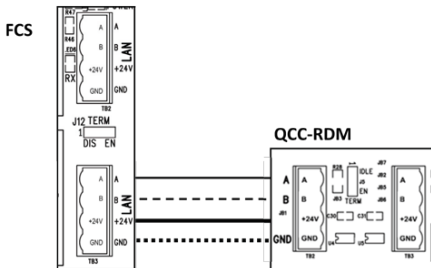

6 SYSTEM OPERATION & CONFIGURATION

6.1 Navigating the Menu Structure

There are three push-button keys to the right of the display that are used to navigate through the QCC-RDM Remote Display menu structure. To enter the menu, press E.

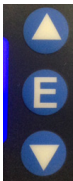

ARROW UP - used for going up through the menus or incrementing values or selecting an alpha character

ENTER - used primarily as an enter key, either for getting to the next screen or stepping through a numeric or alpha value

ARROW DOWN - used for scrolling down through the menus or decrementing values or selecting an alpha character

After entering the menus, pressing the **ARROW UP** key will normally take you to the Exit screen. Most menus are circular and will bring you back to the Exit screen.

6.2 Accessing the Menu with Passcodes

The main menu structure is broken down by the passcode access entry. These passcodes allow for direct access to the parts of the menu system of interest.

CODE	NAME	DESCRIPTION
1001	Basic	Set LCD Contrast Set Modbus ID Set Baud Rate Mask Channels

6.3 Power Up and Warm-up

Upon power up, if the QCC-RDM is properly connected to the QCC (and the controller's menu is not being accessed), the QCC-RDM will display the same screen that the controller is displaying - the normal display, the on alarm display or the splash screen.

If the QCC menu is being accessed the QCC-RDM will display:

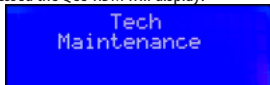

If the connection is not properly wired or configured, the QCC-RDM will display and flash:

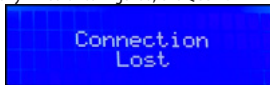

If the QCC-RDM is connected to an FCS, (and the controller's menu is not being accessed), the QCC-RDM will display the gas readings on the display line by line at an approximate speed of 1 to 3 seconds. (factory default)

If a faster scrolling rate is desired, the QCC-RDM Remote Display can be configured to scroll the gas readings page by page at an approximate speed of 5 to 10 seconds. Or the display can be configured to display the top 4 channels in high alarm only. The preferred configuration can be requested at the time of order or changed after installation. The changes are made using the Holding Registers.

NOTE: After the warm up period of the transmitters, the system may exhibit gas alarm condition(s) if any of the sensors have not completely stabilized during the warm up period. This is normal and the length of time the gas alarms exist is dependent upon the length of time since the unit was last powered up and the state of the environment it is installed in. After warm up, only the display

should be active, indicating normal operation.

6.4 Normal Display

In normal operation, the QCC-RDM Remote Display will display the channel numbers with their corresponding gas type and level. When connected to a QCC, if fewer than 4 channels are being used, there will be a blank line for each channel not being used. For example, the image below shows channel 1 and 2 in use only.



Because the FCS can accept up to 128 channel inputs, when connected to the FCS, the QCC-RDM will display the channel numbers as 3 digits long (ie. 001, 002, etc.).

At the end of each line a letter may be displayed that provides information about the status of the Channel:

Letter	Description
none	System working normally
d	Channel disabled
F	Channel is in Fault condition
C	Channel cannot communicate with transmitter
c	Channel Configuration Fault

L	Channel is in low alarm
M	Channel is in mid alarm
H	Channel is in high alarm
S	Channel has a STEL alarm
T	Channel has a TWA alarm
I	Channel has an IDLH alarm

Example of a Fault condition:



NOTE: The display may show additional information related to the channels and relays depending on additional settings that can be enabled. Some of these settings are Override and ON/OFF Delays. These will show a counter indicating how much time is remaining until the action will end or start. For more information, refer to the *QCC Operation Manual*.

When connected to a QCC, depending on how the QCC display is configured, the QCC-RDM may show a different screen than the normal display. The QCC can be configured to show the Normal, Splash Screen or On Alarm screens. The QCC-RDM will show the same display the QCC has been configured to show. To change the display, refer to the *QCC Installation Manual* or the *QCC Operation Manual*.

NOTE: You can temporarily view the Splash Screen on the QCC-RDM by pressing the ARROW UP button once. This allows you to check the model and firmware version of the QCC-RDM. The screen

will display this information and then return to the Normal Display.

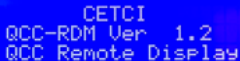

```
CETCI
QCC-RDM Ver 1.2
QCC Remote Display
```

6.5 Set LCD Display Contrast Level

The contrast level of the LCD display can be changed to be made more visible in high light, low light and/or different temperatures that may require a different contrast setting.

In the Basic Menu (passcode 1001), press the ARROW keys to scroll through the menu and select Set LCD Contrast. Press E to select.

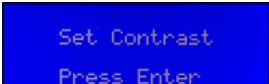

```
Set Contrast
Press Enter
```

Use the ARROW buttons to change the numbers according to your preferred brightness/darkness of the display. Press E to save the entry.



```
LCD Contrast Level
  20
  ^
ENTER Accept / EXIT
```

6.6 Mask Channels

The QCC-RDM display can be configured to show or not show each channel's data. The default setting is to display all channels. If connected to the QCC, to display only the channels of interest, in the Basic Menu (passcode 1001), press the ARROW keys to scroll through the menu and select Mask Channels.

```
Mask Channels
Press Enter
```

Press E to select. Use the ARROW keys to choose SHOW or HIDE the information for each channel.

```
Channel Mask
Ch1 Ch2 Ch3 Ch4
SHOW SHOW HIDE HIDE
      ^
```

Example of QCC-RDM display with Channel 3 and Channel 4 hidden:

```
1 CO          0 PPM
2 NO2        0.0 PPM
```

NOTE: If the QCC-RDM is connected to an FCS, it doesn't make sense to mask any channels because there will usually be more than 4 channels. The scrolling function is associated with one of the four displayed lines, not a particular channel. The result of masking a channel will just eliminate one of the lines that could be used to display the gas reading information.

6.7 Modbus® Settings

The QCC-RDM operates on a local area network (LAN) using Modbus® RS-485 RTU serial communications. In order for communication to be successful between devices, be sure your network connection is complete, the network termination switches are set appropriately and all the devices are configured with the same baud rate, character format, etc. Each device will have its own unique Modbus® ID.

6.7.1 Change Modbus® ID

The QCC-RDM Remote Display has two Modbus® IDs. The first is used to read and write to the Holding Registers when changing the settings, resulting in a response to every request sent. This default Modbus® ID is 230.

The second Modbus® ID is used to receive the screen updates from the QCC. There is no response from the QCC-RDM on this line. This Broadcast Modbus® ID number is 253 and it cannot be changed. The advantage of having the second Modbus® ID is to save network traffic. If there are several QCC-RDMs listening to the same QCC or FCS, they each don't need to respond to broadcast screen updates.

If you would like to change the read and write Modbus® ID, (adding a 2nd, 3rd or 4th QCC-RDM to the system) their IDs should be consecutive, starting with the base address 231.

In the Basic Menu (passcode 1001), press the ARROW keys to scroll through the menu and select Set Modbus® ID. Press E to select.



Use the ARROW keys to enter the preferred Modbus® ID.

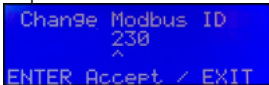

6.7.2 Set Baud Rate

All devices on the same network must have the same baud rate. The factory default Modbus® baud rate for all CETCI Modbus® devices is 19,200. If you need to change the baud rate, in the Basic Menu (passcode 1001), press the ARROW keys to scroll through the menu and select Set Baud rate.

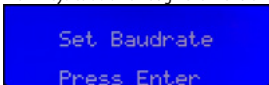

Set Baudrate
Press Enter

Press E to select. Use the ARROW keys to scroll through the list of baud rates to choose from:

- 9,600
- 14,400
- 19,200 (default)
- 38,400
- 57,600
- 76,800
- 115,200

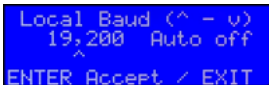

Local Baud (^ - v)
19,200 Auto off
^
ENTER Accept / EXIT

If you would like the QCC-RDM to automatically select the appropriate baud rate, choose Auto on. The QCC-RDM will sample existing traffic on the network to determine the correct baud rate. This is useful if the QCC-RDM gets lots of framing errors. It will automatically change the baud rate until it stops getting the errors. If Auto is turned off, the QCC-RDM will be locked into whatever baud rate has been selected.

Press ENTER to save you selection and exit.

NOTE: The QCC or FCS baud rate and the QCC-RDM baud rate (and all devices on the QCC or FCS LAN network) must be the same for the system to work.

7 MAINTENANCE

The QCC-RDM Remote Display requires no assembly and virtually no maintenance. It is important to ensure that water and/or dust is not somehow entering the enclosure and physically damaging the circuit board or internal components.

8 TROUBLE SHOOTING

QCC-RDM won't power up. (blank display)

Is the power properly connected? Check the connections. Refer to Section 5.5 *Wiring Power Connections*. Check the display contrast. Refer to Section 6.5 *Set LCD Display Contrast Level*.

QCC-RDM constantly shows "Connection Lost". Check that the number of Remote Devices is set correctly in the QCC or FCS.

QCC-RDM cannot be seen by the Controller and/or the BAS / DDC on the Modbus® network.

- Check the Baud rate. All devices in the network must have the same Baud rate. Refer to Section 6.7.2 *Change Modbus® Baud Rate*.
- Check the Modbus® ID. Each device must have a unique ID assigned to it. Refer to Section 6.7.1 *Change Modbus® ID*.
- Check that local area network wiring is correct, especially the A and B lines to make sure they are not swapped between devices on the network.

- Check that local area network wiring is correct, especially the A and B lines to make sure they are not swapped between devices on the network.

Should you require further help, please contact our Service Department:

Critical Environment Technologies Canada Inc.

Unit 145, 7391 Vantage Way, Delta, BC, V4G 1M3, Canada

Toll Free: +1.877.940.8741

Telephone: +1.604.940.8741

Fax: +1.604.940.8745

Email: service@cetci.com

Website: www.critical-environment.com

NOTES



Critical Environment Technologies Canada Inc.

Unit 145, 7391 Vantage Way, Delta, BC, V4G 1M3, Canada

Toll Free: +1.877.940.8741

Tel: +1.604.940.8741

Fax: +1.604.940.8745

www.critical-environment.com

QRDM20170515-B