



Rev. C | 2017.06

DCC-MRI

Oxygen Sampling System

www.critical-environment.com

TABLE OF CONTENTS

1 POLICIES	5
1.1 Important Note.....	5
1.2 Warranty Policy.....	5
1.3 Service Policy.....	6
1.4 Copyrights.....	7
1.5 Disclaimer.....	7
1.6 Revisions.....	7
2 INTRODUCTION	8
2.1 General Description	8
2.2 Key Features.....	9
3 INSTRUMENT SPECIFICATIONS	9
3.1 Technical Specifications.....	9
3.2 Standard Enclosure Dimensions.....	12
4 SENSOR SPECIFICATIONS	13
4.1 Internal Oxygen Sensor (inside the LPT-A)	13
5 FEATURES & FUNCTIONS	14
5.1 DCC-MRI Exterior Enclosure.....	14
5.2 DCC-MRI Interior System Layout	15
5.2.1 Left Side of Enclosure.....	15
5.2.2 Right Side of Enclosure	17
5.3 LPT-A Transmitter Interior System Layout	18
6 INSTALLATION	19
6.1 General Safety Warnings.....	19
6.2 Protection Against Electrical Risks	19
6.3 Protection Against Mechanical Risks.....	20
6.4 System Installation	20
6.4.1 EMI and RF Interference Considerations.....	20
6.5 Standard Enclosure Mounting Components	21
6.5.1 Enclosure Base.....	21
6.5.2 Enclosure Top.....	22

- 6.6 Wiring Power Connections22
 - 6.6.1 AC Low Voltage Power Wiring to the DCC-MRI.....23
- 6.7 Relay Connections.....23
- 6.8 Analog Output23
- 7 OPERATION24**
 - 7.1 General System Operation24
 - 7.2 Warm Up.....25
 - 7.3 Display Select.....25
 - 7.4 Fault Detection26
 - 7.5 Jumpers26
 - 7.6 Test/Config Mode Functions.....27
 - 7.6.1 How to Navigate the Test/Config Menu28
 - 7.6.2 Hold Relay #.....28
 - 7.6.3 Disable Channel #28
 - 7.6.4 Display Mode28
 - 7.6.5 CH# Current Test.....28
 - 7.6.6 CH# Current Calibration.....29
 - 7.6.7 Output CH1 Max Follow29
 - 7.6.8 CH# Alarm# Direction29
 - 7.6.9 CH# Change 4-20 mA Output to 0-20 mA Output29
 - 7.6.10 Output CH# Fault Level29
 - 7.6.11 Relay Fault State29
 - 7.6.12 Buzzer Fault State30
 - 7.6.13 Relay Latching30
 - 7.6.14 Relay Hold Off Enable / Disable30
 - 7.6.15 Setting the Hold Off Time Relay30
 - 7.7 Audible Alarm Operation30
 - 7.8 Setting Buzzer ON Delay31
 - 7.9 Adjusting Alarm Set Points for CH131
 - 7.10 Setting Relay ON / OFF Delays.....32
 - 7.11 Minimum Runtime33

8 CALIBRATION	33
8.1 Testing the Vacuum Switch Calibration	33
8.2 Calibration Specifications.....	34
8.2.1 Gas.....	34
8.2.2 Regulators & Flow.....	34
8.2.3 Calibration Frequency	34
8.2.4 Gas Testing Frequency (Bump Testing).....	34
8.3 Calibration Procedure (Done on the LPT-A)	35
9 ACCESSORIES	39
9.1 Sample Draw Pump Calibration Kit	39
9.2 Magnetic Wand.....	39
10 MAINTENANCE	39
11 TROUBLESHOOTING	40
11.1 Noisy Pump.....	40
11.2 Oxygen Sensor - Low Reading.....	40

1 POLICIES

1.1 Important Note

Read and understand this manual prior to using this instrument. Carefully read the warranty policy, service policy, notices, disclaimers and revisions on the following pages.

This product must be installed by a qualified electrician or factory trained technician and according to instructions indicated in this manual. This instrument should be inspected and calibrated regularly by a qualified and trained technician. For more information, refer to Sections *8 Calibration* and *10 Maintenance* of this manual.

This instrument has not been designed to be intrinsically safe. For your safety, **do not** use it in classified hazardous areas (explosion-rated environments).

INSTRUMENT SERIAL NUMBER:

PURCHASE DATE:

PURCHASED FROM:

1.2 Warranty Policy

Critical Environment Technologies Canada Inc. (CETCI), also referred to as the manufacturer, warrants this instrument, (excluding sensors, battery packs, batteries, pumps and filters) to be free from defects in materials and workmanship for a period of **two years from the date of purchase from our facility**. The sensors have a warranty period of **one year on a pro-rated basis from the date of purchase from our facility**. If the product should become defective within this warranty period, we will repair or replace it at our discretion.

The warranty status may be affected if the instrument has not been used and maintained as per the instructions in this manual or has been abused, damaged, or modified in any way. This instrument is only to be used for purposes stated herein. The manufacturer is not liable for auxiliary interfaced equipment or consequential damage.

Due to ongoing research, development, and product testing, the manufacturer reserves the right to change specifications without notice. The information contained herein is based on data considered accurate. However, no warranty is expressed or implied regarding the accuracy of this data.

All goods must be shipped to the manufacturer by prepaid freight. All returned goods must be pre-authorized by obtaining a Returned Merchandise Authorization (RMA) number. Contact the manufacturer for a number and procedures required for product transport.

1.3 Service Policy

CETCI maintains an instrument service facility at the factory. Some CETCI distributors / agents may also have repair facilities; however, CETCI assumes no liability for service performed by anyone other than CETCI personnel.

Repairs are warranted for 90 days after date of shipment (sensors have individual warranties).

Should your instrument require non-warranty repair, you may contact the distributor from whom it was purchased or you may contact CETCI directly.

Prior to shipping equipment to CETCI, contact our office for an Returned Merchandise Authorization (RMA) number. All returned goods must be accompanied with an RMA number.

If CETCI is to do the repair work, you may send the instrument, prepaid, to:

Attention: Service Department
Critical Environment Technologies Canada Inc.
Unit 145, 7391 Vantage Way
Delta, BC, V4G 1M3

Always include your RMA number, address, telephone number, contact name, shipping / billing information, and a description of the defect as you perceive it. You will be contacted with a cost estimate for expected repairs, prior to the performance of any service work.

For liability reasons, CETCI has a policy of performing all needed repairs to restore the instrument to full operating condition.

Pack the equipment well (in its original packing if possible), as we cannot be held responsible for any damage incurred during shipping to our facility.

1.4 Copyrights

This manual is subject to copyright protection; all rights are reserved. Under international and domestic copyright laws, this manual may not be copied or translated, in whole or in part, in any manner or format, without the written permission of CETCI.

All software which CETCI utilizes and/or distributes holds a proprietary interest and is also subject to copyright protection and all rights are reserved. No party may use or copy such software in any manner or format, except to the extent that CETCI grants them a license to do so. IF SOFTWARE IS BEING LOADED ONTO MORE THAN ONE COMPUTER, EXTRA SOFTWARE LICENSES MUST BE PURCHASED.

1.5 Disclaimer

Under no circumstances will CETCI be liable for any claims, losses or damages resulting from or arising out of the repair or modification of this equipment by a party other than CETCI service technicians, or by operation or use of the equipment other than in accordance with the printed instructions contained within this manual or if the equipment has been improperly maintained or subjected to neglect or accident. Any of the foregoing will void the warranty.

Under most local electrical codes, low voltage wires cannot be run within the same conduit as line voltage wires. It is CETCI policy that all wiring of our products meet this requirement. It is CETCI policy that all wiring be within properly grounded (earth or safety) conduit.

1.6 Revisions

This manual was written and published by CETCI. The manufacturer makes no warranty or representation, expressed or implied including any warranty of merchantability or fitness for purpose, with respect to this manual.

All information contained in this manual is believed to be true and accurate at the time of printing. However, as part of its continuing efforts to improve its products and their documentation, the manufacturer reserves the right to make changes at any time without notice. Revised copies of this manual can be obtained by contacting CETCI or visiting **www.critical-environment.com**.

Should you detect any error or omission in this manual, please contact CETCI at the following address:

Critical Environment Technologies Canada Inc.

Unit 145, 7391 Vantage Way, Delta, BC, V4G 1M3, Canada

Toll Free: +1.877.940.8741

Telephone: +1.604.940.8741

Fax: +1.604.940.8745

Email: marketing@cetci.com

Website: www.critical-environment.com

In no event will CETCI, its officers or employees be liable for any direct, special, incidental or consequential damages resulting from any defect in any manual, even if advised of the possibility of such damages.

2 INTRODUCTION

2.1 General Description

Thank you for purchasing our self-contained DCC-MRI Oxygen Sampling System. The DCC-MRI has been developed for Magnetic Resonance Imaging (MRI) room applications in hospitals and clinics. Due to the strong magnetic field inside the MRI room, electronic equipment does not operate properly when mounted inside the room. The DCC-MRI system is designed to be installed outside of the MRI room with a sampling tube running from the monitoring system to the sampled environment.

All DCC-MRI Oxygen sampling systems are packaged with an LPT-A Analog Transmitter with an internal oxygen sensor (measurement range 0 - 25% volume) and have a flow detector, internal sample draw pump and an internal adjustable flow meter.

Features include two 4 - 20 mA outputs, one alarm level line voltage relay with field configurable time delays and trigger levels, a blocked flow alarm indicating a dirty filter or clogged tubing, a side mounted audible buzzer, door mounted Silence push-button and an LCD digital display with LED indicators for channel alarm status and fault conditions.

If after reading through the manual, you have any questions, please do not hesitate to contact our service department for technical support.

2.2 Key Features

- 2x16 character LCD display with embedded LED indicators for CH1, CH2 and Fault
- Loud side mounted buzzer
- Blocked flow alarm
- Internal sample draw pump
- Adjustable flow meter
- One 5-amps SPDT dry contact relay
- One configurable 4-20 mA output
- Thermal resetting fuses
- RoHS compliant circuit boards
- Standard water / dust tight, corrosion resistant enclosure (drip proof)
- Conforms to CSA, UL, CE and FCC standards

3 INSTRUMENT SPECIFICATIONS

3.1 Technical Specifications

GAS TYPE

Oxygen (O₂)

MECHANICAL

Enclosure	Water / dust tight corrosion resistant polyester reinforced fiberglass
Weight	7.5 lbs (3.4 kg)
Size	223 mm x 267 mm x 159 mm (8.8" x 10.5" x 6.3")
Tubing (not included)	1/4" OD Factory tested distance : 50 ft (15.24 m)

ELECTRICAL

Power Requirement	24 VAC nominal, 10 W, Class 2
Current Draw	400 mA RMS @ 24 VAC
Wiring	24 VAC two-conductor 14 - 18 gauge shielded stranded within conduit
Fuses	Automatic resetting thermal

INPUT / OUTPUT

Audible Alarm	Loud, side mounted buzzer, rated 90 dB @ 30 cm
Relays	One SPDT dry contact relay, rated 5 amps @ 240 VAC
Flow	Normal operation: 1.0 LPM Flow alarm: less than 0.5 LPM

USER INTERFACE

Display	2x16 character LCD digital display with LED indicating lights for "CH1" state, "CH2" state and "Fault"
SILENCE Push-button	Temporarily clears buzzer and latched relay

ENVIRONMENTAL

Operating Temperature	-20°C to 40°C (-4°F to 104°F)
Operating Humidity	15 - 90% RH non-condensing

CERTIFICATIONS

Model: DCC-MRI

S/N: DCCMRI151200010

Rating: 24 VAC, 50-60 Hz 10W, Class 2

CERTIFIED FOR ELECTRIC SHOCK & ELECTRICAL FIRE HAZARD ONLY. LA CERTIFICATION ACNOR COUVRE UNIQUEMENT LES RISQUES DE CHOC ELECTRIQUE ET D'INCENDIE D'ORIGINE ELECTRIQUE.

Conforms to: CSA-C22.2 No. 205-12, UL508 (Edition 17):2007

Conforms to: EMC Directive 2004/108/EC, EN 50270:2006, Type 1, EN61010

Conforms to: FCC. This device complies with Part 15 of the FCC Rules. Operation is subject to the following two conditions: (1) This device may not cause harmful interference, and (2) this device must accept any interference received, including interference that may cause undesired operation.

For indoor use only.



NOTES:

- System is configured such that all relays are "FAIL SAFE" (relay coils are always energized in non-alarm state).

3.2 Standard Enclosure Dimensions

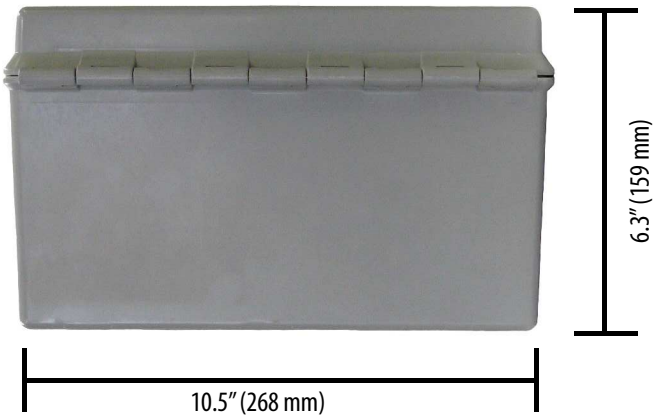

4 SENSOR SPECIFICATIONS

4.1 Internal Oxygen Sensor (inside the LPT-A)

Oxygen (O₂)

Type	Electrochemical
Range	0 - 25% volume
Response Time (T ₉₀)	< 15 seconds
Operating Temperature	-30°C to 55°C (-5°F to 131°F)
Operating Humidity	5 – 95% RH non-condensing
Operating Pressure	80 – 120 kPa
Repeatability	N/A
Maximum Zero Shift	N/A
Clean Air Output Drift	< 2% change in 3 months
Expected Life Span	Approximately 3 years
Calibration	Every 6 months (depending on application)
Cross Sensitivity	CO ₂ sensitivity: 0.1% change in O ₂ reading per % CO ₂ in 5% CO ₂

5 FEATURES & FUNCTIONS

5.1 DCC-MRI Exterior Enclosure



NUMBER	FEATURE	FUNCTION
1	Display	LCD digital display
2	LED Indicators	Indicates state of CH1, CH2 and FAULT
3	SILENCE Push-button	Temporarily clears buzzer and latched relays
4	Door Hinge	Secures door
5	Door Screws	Secures door
6	Audible Alarm	Side mounted buzzer
7	Inlet Fitting	Sampled air inlet
8	Outlet Fitting	Exhausted air out

5.2 DCC-MRI Interior System Layout

5.2.1 Left Side of Enclosure

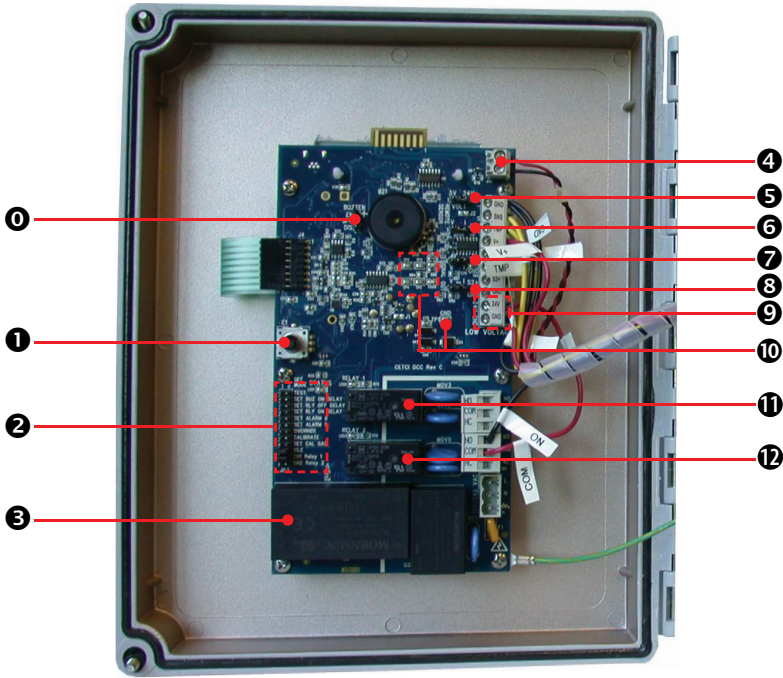

NUMBER	FEATURE	FUNCTION
①	JP4 Buzzer Enable/Disable	Used to enable or disable the DCC-MRI internal buzzer, side mounted buzzer and remote strobe/horn if connected. Factory default is enabled.
②	Rotary Encoder E1	Used for setting values in conjunction with jumpers.
③	Jumper Bank JP3 Config/ Cal / Test Jumpers	Used to select different configuration and calibration modes.
④	Power Supply Transformer	Provides low VDC power from 120 or 240 VAC input

4	J8 Buzzer Connection	Connection for side mounted buzzer or remote horn and/or strobe. Provides 24V, 300 mA (depending on the draw of the remote sensor that is connected).
5	Jumper JP1 Remote Device Voltage	Factory set for connection to LPT-A
6	Jumper JP2	Factory set for connection to LPT-A
7	Jumper JP5	CH1 analog output voltage or current select
8	Jumper JP6	CH2 analog output voltage or current select
9	Low Voltage Wiring Terminal	For low voltage power connections and LPT-A hookup
10	Test Points	TP1 for multimeter ground connection TP2 and TP3 monitoring Output 1 (S1) TP4 and TP5 monitoring Output 2 (S2)
11	Dry Contact Relay 1	Configurable for use when O ₂ reading alarm condition occurs.
12	Dry Contact Relay 2	Shuts down sample draw pump when Flow Alarm condition occurs. (factory set)

5.2.2 Right Side of Enclosure

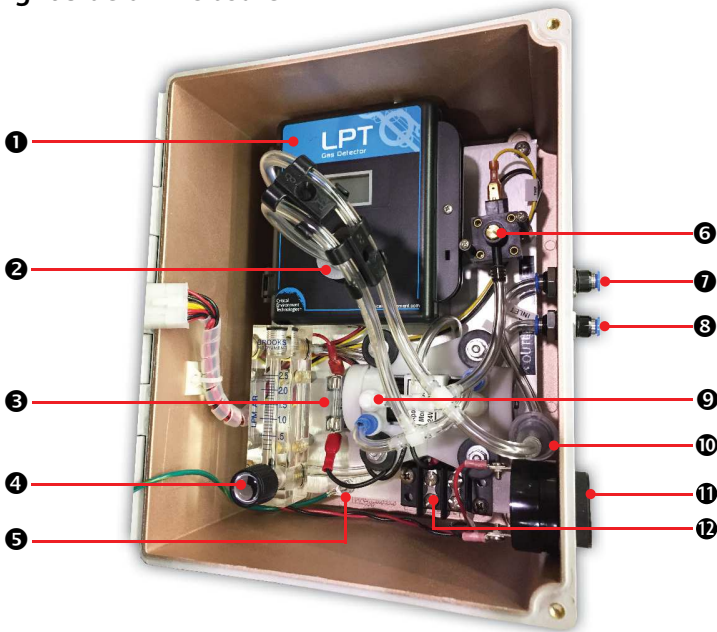

NUMBER	FEATURE	FUNCTION
1	LPT-A	LPT-A Oxygen Transmitter
2	Sensor Flow Adapter	Diffuses the sampled air to the sensor
3	Fuse	Pump fuse 0.5 amps
4	Flow Meter	Turn knob to adjust the flow rate
5	Earth Ground Connection	Connect with ground from incoming power
6	Vacuum Switch	Tells the DCC-MRI to turn the sample draw pump on or off
7	Inlet Fitting	Connection for tubing for incoming air
8	Outlet Fitting	Connection for tubing for exhausted air
9	Sample Draw Pump	Pump that draws in the air (or gas)
10	Filter	Sample air particulate filter
11	Side Mounted Buzzer	External audible alarm
12	Incoming Power Terminal Block	Incoming power connection, isolated 24 VAC supply (to prevent blowing up the rectifiers)

5.3 LPT-A Transmitter Interior System Layout

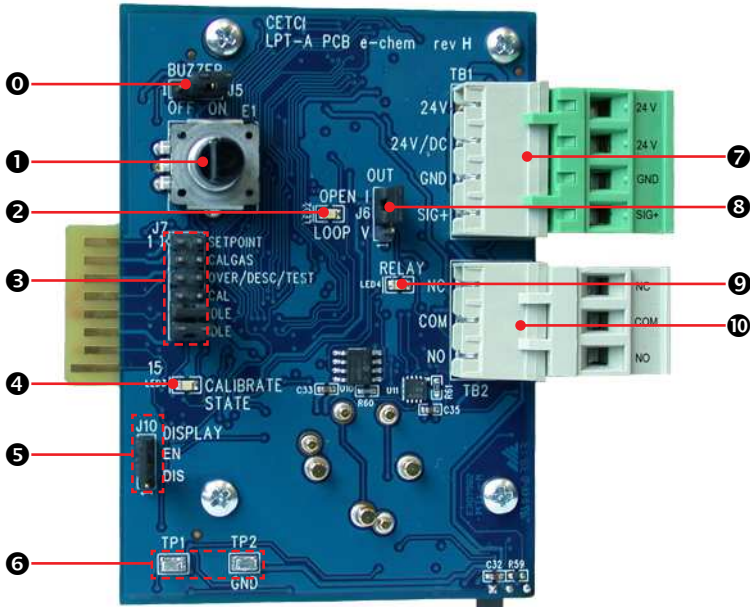

NUMBER	FEATURE	FUNCTION
0	Jumper J5	Enables / Disables the buzzer in the LPT-A. Factory default is disabled. Should remain disabled. Use Jumper in DCC-MRI to enable/disable the buzzer
1	Rotary Encoder	Used to set calibration values, etc. with the jumpers
2	Open Loop LED	Lights up if there is no connection for current output
3	Jumper J7	Jumpers for calibration and test functions
4	Calibrate State LED	Further prompting for calibration operation

5	Jumper J10	Enables / Disables the display of the measured gas level
6	Test Points: TP1 & TP2	For measuring voltage output
7	Wiring Terminal TB1	Pluggable terminal for power and signal output
8	Jumper J6	Select either current or voltage output
9	Relay LED	Indicates (when on) that the gas level is above the trip point (the relay will indicate alarm level)
10	Relay Terminal TB2	Pluggable terminal for relay connections

6 INSTALLATION

6.1 General Safety Warnings

The DCC-MRI is intended for indoor use, permanently mounted outside the MRI Room, connected to tubing inside the room at breathing zone height (4 to 6 ft above ground). It should be protected from extreme weather conditions.

NOTE: For wet environment applications, use liquid tight conduit hubs wherever conduit enters the enclosure.

The DCC-MRI requires no assembly and virtually no maintenance other than regular calibration of the LPT-A Oxygen sensor and ensuring that excess water or dust is not somehow entering the enclosure and physically damaging the circuit board or internal components. There are no serviceable elements other than the calibration instructions outlined in this manual. There are no replaceable components except the sensor and the air filter. The condition of the air filter should be checked routinely.

6.2 Protection Against Electrical Risks

Warning High Voltage. Indicates hazardous voltage may be present in the area inside the DCC-MRI enclosure marked with this symbol.



Disconnect all power before servicing. There may be multiple power sources. Power supply must have a building installed circuit breaker /switch that is suitably located and easy to access when servicing is required and should be labelled as DCC-MRI supply (disconnecting power to the DCC-MRI). Appropriate markings should be visible at the circuit breaker / switch that is supplying power to the DCC-MRI.

This device may interfere with pacemakers. Modern pacemakers have built-in features to protect them from most types of interference produced by other electrical devices you might encounter in your daily routine. If you have a pacemaker, follow your healthcare provider's instructions about being around this type of equipment.

6.3 Protection Against Mechanical Risks

Be aware that the DCC-MRI enclosure has a hinged door that could potentially pinch fingers and the sharp edges and/or jumper pins on the board could potentially prick or cut fingers if not handled carefully.

6.4 System Installation

The DCC-MRI is approximately 7.5 lbs (3.4 kg). A large, deep enclosure is required to accommodate the internal LPT-A Analog Transmitter, sample pump, flow meter, in-line filter and incoming power terminal block.

This instrument should be installed outside the MRI room with soft tubing running between the O₂ monitor and the target area to be monitored. Enclosure mounting feet and instructions are secured on the inner door in a plastic bag. Install the enclosure on a flat secure surface using the four mounting feet. After installation, power up and testing, tighten the door screws to prevent rattling from vibration.

6.4.1 EMI and RF Interference Considerations

All electronic devices are susceptible to EMI (Electromagnetic Interference) and RFI (Radio Frequency Interference). Our detectors have been designed to reduce the effects of these interferences and we meet CSA FCC and CE requirements for these type of devices. There are still circumstances and levels of interference that may still cause our equipment to respond to these interferences and cause them to react as if there has been gas detected. There are some installation procedures that will reduce the likelihood of getting faulty readings:

1. Locate the detectors and controllers out of the way from normal foot traffic and high energy equipment.
2. Confirm the devices are properly grounded using conduit and shielded cabling.

- 3. Inform operators and technical staff working in the surrounding area to be aware of these possible conditions and that two way radios, bluetooth enabled devcies, cell phones and other electrical equipment may interfere with the response of the gas detectors.

6.5 Standard Enclosure Mounting Components

6.5.1 Enclosure Base

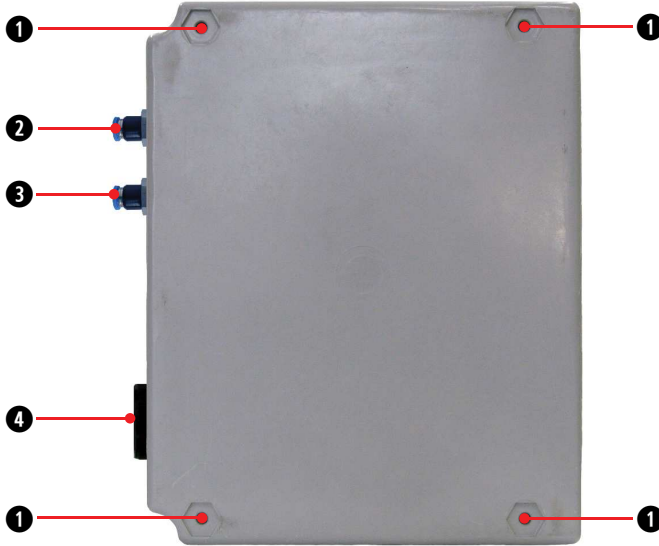

NUMBER	FEATURE
1	Mounting Holes
2	Inlet Fitting
3	Outlet Fitting
4	Buzzer

6.5.2 Enclosure Top



NUMBER	FEATURE
①	Door Hinge
②	Inlet Fitting

6.6 Wiring Power Connections

All wiring should be run within properly grounded (earth or safety) conduit. Signal output and supply should be in shielded cable. The cable shield should be connected to earth ground at the controller/power supply that is providing power for the DCC-MRI. Low voltage wiring must not be within the same conduit as line voltage wiring.

NOTE: WARRANTY MAY BE VOID IF DAMAGE OCCURS TO CIRCUIT BOARD COMPONENTS FROM THE USE OF SOLID CORE WIRE ATTACHED DIRECTLY TO THE WIRING TERMINALS.

When using solid core wiring for distribution (in the conduit), use stranded wire pigtailed 18 awg within the enclosure to connect to the circuit board. The rigidity of solid-core wire can pull a soldered terminal strip completely off a circuit board and this will not be covered under warranty.

6.6.1 AC Low Voltage Power Wiring to the DCC-MRI

Isolated 24 VAC is supplied to the incoming power terminal block (to prevent blowing up the rectifiers). Be sure to connect the earth ground. A class 2 or better transformer must be used. The stated max current draw of the DCC-MRI in this mode is 400 mA.

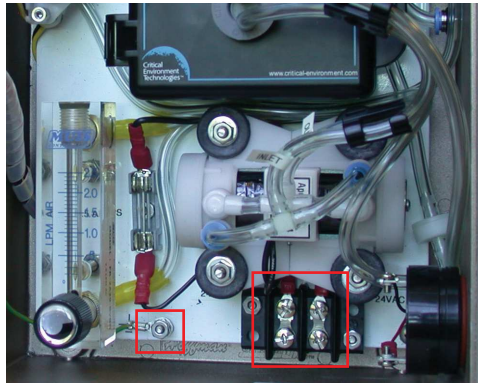

6.7 Relay Connections

The DCC-MRI has two SPDT (single pole, double throw) dry contact relays, one of which is factory configured to shutoff the sample draw pump inside the enclosure. Only Relay 1 is available and can be user configured as the application requires, such as triggering a fan starter or coil for a ventilation system.

NOTE: Equipment connected to the relay cannot draw more than 5 amps @ 240 V start-up and / or operational current.

The system does not provide any power from the relay terminals. Dry contacts operate like a switch to simply activate (switch on) or de-activate (switch off) equipment to be controlled, such as fan starters.

The DCC-MRI system is designed to be fail-safe, any equipment to be controlled by Relay 1 should be wired to the “NC” (Normally closed) and “COM” (Common) terminals. **The relay coils are normally energized in non-alarm state for failsafe operation.**

6.8 Analog Output

Both the CH1 and CH2 analog output are available for communicating with a DDC or BAS.

The default output mode for both channels is 4-20 mA current loop. For CH1, zero concentration of Oxygen will output 4 mA and a full scale concentration (eg. 25% Oxygen) will output 20 mA. In normal operation (ie. 20.9% oxygen) the output is equal to 17.4 mA.

CH2 analog output indicates the pump status. An output of 4 mA indicates normal operation, and an output of 20 mA indicates the flow is restricted and the pump will shut off.

The analog output can be changed to voltage (2 - 10 V) by moving the JP5 jumper to the (V) volt position.

$$\text{outputLevel} = [(\text{gasReading}/\text{gasRange}) * \text{outputRange}] + \text{outputZero}$$

7 OPERATION

7.1 General System Operation

The DCC-MRI constantly monitors the target area air and indicates real time Oxygen levels on the display. Normal Oxygen levels in a room with good air exchange are approximately 20.8% to 21.0% volume.

The sample air enters the system through the tubing attached to the inlet fitting, then flows through the particulate filter and into the LPT-A where the air is drawn across the sensor and then into the pump. After exiting the pump, it enters the flow meter (Refer to *Section 5.2.2 Right Side of Enclosure* for location) and exits out the outlet. Between the particulate filter and the LPT-A is the vacuum switch, which detects the vacuum strength in the line.

If the Oxygen level drops below 19.5%, Channel 1 LED will turn amber, the buzzer will sound and relay 1 will be de-energized. The buzzer can be silenced for set amount of time by pressing the "Silence" push-button. Once the Oxygen level stabilizes, the DCC-MRI returns to normal operation.

The Oxygen sensor life span is approximately three years. If the Oxygen level drops dramatically low, and the system goes into full alarm and will not recover or reset, the Oxygen sensor may have expired.

If the inlet tube becomes blocked and/or the filter becomes dirty, the display will show Flow Alarm, Channel 2 LED will turn red, the buzzer will sound and the pump will shut off. Remove the blockage or replace the dirty air filter and press the "Silence" push-button to stop the buzzer, restart the pump and clear the latching.

As with all sensors, regular calibration maintenance is recommended and required for best performance. Use Nitrogen (100%) for the null adjustment of the sensor and Oxygen span gas (20.9% vol.) for the span adjustment which can be fed into the inlet fitting. A Demand Flow Regulator must be used to avoid drawing down the pump. The calibration of the system can only be done at the LPT-A transmitter.

7.2 Warm Up

When the DCC-MRI is powered up, the LCD display will turn on, relays will energize and the Channel LED for each channel will blink Green while the unit warms up. All alarms will be disabled for two to five minutes during the system warm up period. After the warm up period, the system may exhibit a gas alarm condition if the Oxygen sensors has not completely stabilized during the warm up period. This is normal and the length of time the gas alarm exists is dependent upon the length of time since the unit was last powered up, and the state of the environment it is installed in.

After the warm up period, the LCD will show the gas type, gas reading and gas units. The LED for both Channels will be illuminated GREEN indicating normal operation.

Allow the sensor several hours to stabilize before making any desired adjustments except for the flow rate which can be adjusted right after power up. Make sure the end user sampling tubing (not supplied by CETCI) has been installed and attached to the inlet fitting. If the exhausted sampled air needs to be redirected elsewhere, attach another length of tubing to the outlet fitting and position as needed.

The flow meter rate is set at the factory prior to shipping. If the flow meter is not indicating the correct flow, you can adjusted it. When using the Demand Flow Regulator, the flow rate should be at least 1.0 LPM. When using the regular calibration adapter, the flow rate should be 0.5 LPM.

NOTE: It is NOT recommended to use a sample hose (connected to the inlet fitting) that is more than 50 ft (15.24 m) long without further testing to make sure enough air flow is detected by the sensor.

The inlet and outlet fittings are 1/4" O.D.

7.3 Display Select

There are two types of display modes to choose from: normal display mode and minimal display mode. The factory default setting is the normal display mode, which will display the gas type, gas reading and gas units for CH1.

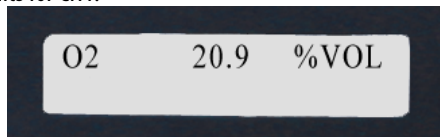

The minimal display mode can be set from the test menu. This mode will only display the gas

type for CH1. To change the display mode, see Section 7.6 *Test/Config Mode Functions*.

7.4 Fault Detection

The DCC-MRI has built in fault detection. In the event of a problem with the measurement circuitry or a sensor sending a reading below zero, the unit will indicate a fault condition on the display. The FAULT LED will turn solid RED and the CH1 or CH2 LED that has the fault will blink RED and a question mark will appear next to the reading.

Normal operation will resume once the fault condition has been corrected.

NOTE: How the relay, buzzer and analog output for CH1 responds during a fault condition are field configurable.

7.5 Jumpers

There are five single jumper positions (JP1, JP2, JP4, JP5 and JP6) and one bank of 12 jumpers (JP3). JP3 provides the ability to monitor and configure a wide range of values.



To start a configuration, place one jumper on the channel / relay select position CH1 Relay1 and place the other jumper on the function position you want to configure:

JP3 POSITION NAME	FUNCTION
TEST	Puts the unit into test/config mode
SET BUZ ON DELAY	Configure internal audible alarm ON delay

SET RLY OFF DELAY	Configure selected Relay OFF delay
SET RLY ON DELAY	Configure selected Relay ON delay
SET ALARM 2	(Disabled - cannot be used)
SET ALARM 1	Enable/Disable/Set selected Channel alarm 1 level
OVERRIDE	Used during calibration to override a zero or span value that is out of nominal range
CALIBRATE	Begin the calibration procedure
SET CAL GAS	Adjust the gas concentration used in calibration
IDLE	Jumper default / resting position
CH1 Relay 1	Select CH1 or Relay 1
CH2 Relay2	(No configurations can be set or changed, cannot be used)

To end a configuration and save the changes, move the jumper from the function position back to the IDLE position. The other jumper can remain on the channel / relay select position CH1 Relay1.

NOTE: The Channel select jumper should be left on CH1 Relay 1 position as no configuration can be changed on CH2 Relay 2. The other jumper should rest in the IDLE position during normal operation.

7.6 Test/Config Mode Functions

The test/config mode allows you to test and configure the basic functionality of the system.

To enter test/config mode place the JP3 Jumper on the TEST position. When the device enters the test/config mode the buzzer will beep several times and the LEDs will cycle to test their function. Watch for both green and red on the channel LEDs (especially if damage is suspected).

To test the magnetic sensors, in test mode touch the magnetic wand to the white dot (above the D of DCC on the front of the DCC enclosure). The CH1 LED should light up. Use the magnet to touch the second magnetic sensor (white dot above the second C). The CH2 LED should light up.

The Test/Config mode will exit automatically after 5 minutes of no activity. To exit the Test/config mode, move the jumper back to IDLE. Upon exit the unit will return to standard measurement mode.

NOTE: Analog outputs will stay at the level they were currently at prior to entering Test/Config mode.

NOTE: Certain menu items associated with CH2 and Relay 2 will not be accessible or configurable on the DCC-MRI.

7.6.1 How to Navigate the Test/Config Menu

Use the rotary encoder to scroll through the menu selections. Press the SILENCE button to choose the desired menu item. A ">" will appear to the left of the item menu value. Use the encoder to cycle through the possible options (ON/OFF, YES/NO, etc.). Press the SILENCE button to save the selection and return to the main menu. To cancel, remove the jumper from the TEST position back to IDLE.

7.6.2 Hold Relay

The Hold Relay functionality allows you to trip the relay for testing purposes. Enter test/config mode. Use the rotary encoder to scroll to **Hold Rly#** and press the SILENCE button to enter the menu item. Turn encoder clockwise to start or add time to a tripped state. It increases in 5 minute increments (to a maximum of 20 minutes). Press the SILENCE button to exit the menu item and clear the relays.

7.6.3 Disable Channel

Enable or disable one or both gas channels. Enter test/config mode. Use the rotary encoder to scroll to **CH# ON/OFF** and press the SILENCE button to enter the menu item. Use the encoder to choose ON or OFF and press the SILENCE button to save and return to the main menu.

NOTE: You can only enable factory configured channels. If you try to enable a non-configured channel the display will read Bad Config in normal operation.

7.6.4 Display Mode

Set the preferred display mode - regular display or minimal display. Enter test/config mode. Using the rotary encoder, scroll to **Display Style** and press the SILENCE button to enter the menu item. Use the encoder to choose the preferred display mode. Press the SILENCE button to save and return to the main menu.

7.6.5 CH# Current Test

To test the 4-20 mA analog output operations for each channel. Enter test/config mode. Use the rotary encoder to scroll to **CH# Current Test** and press the SILENCE button to enter the menu item. Use the encoder to dial the output up or down. Each turn progresses in increments of

0.1 mA. Press the SILENCE button to return to the main menu.

7.6.6 CH# Current Calibration

To calibrate the analog output for each channel. Hook a multimeter (ammeter) to the analog output port. Enter test/config mode. Use the rotary encoder to scroll to **CH# Current Cal** and press the SILENCE button to enter the menu item. Calibrate the zero by using the encoder to adjust the counts until the desired current is displayed on the multimeter. Press the SILENCE button to move to the 4 mA setting and repeat the process. Repeat again for 20 mA. Press the SILENCE button to return to the main menu.

7.6.7 Output CH1 Max Follow

To enable the output of CH1 to follow the highest level of both gas channels. Enter test/config mode. Use the rotary encoder to scroll to **Out# Max Follow** and press the SILENCE button to enter the menu item. Use the encoder to choose the preferred setting and press the SILENCE button to save and return to main menu.

7.6.8 CH# Alarm# Direction

Use to set the direction (ascending or descending) of the selected alarm. Enter test/config mode. Use the rotary encoder to scroll to **CH# Alarm# Dir** and press the SILENCE button to enter the menu item. Use the encoder to choose the preferred setting and press the SILENCE button to save and return to main menu.

7.6.9 CH# Change 4-20 mA Output to 0-20 mA Output

Use to choose the current output range for the Channel. Enter test/config mode. Use the rotary encoder to scroll to **Output# mA Range** and press the SILENCE button to enter the menu item. Use the encoder to choose the preferred setting and press the SILENCE button to save and return to main menu.

7.6.10 Output CH# Fault Level

Use to set the current level to be output during a FAULT condition. Enter test/config mode. Use the rotary encoder to scroll to **Out# Fault Lvl** and press the SILENCE button to enter the menu item. Use the encoder to choose the preferred setting and press the SILENCE button to save and return to main menu.

7.6.11 Relay Fault State

Use to set the state the relay takes during a FAULT condition (tripped or untripped). Enter test/config mode. Use the rotary encoder to scroll to **Rly# Fault State** and press the SILENCE button to enter the menu item. Use the encoder to choose the preferred setting and press the SILENCE

button to save and return to main menu.

7.6.12 Buzzer Fault State

Use to set the state the buzzer takes during a FAULT condition (ON or OFF). Enter test/config mode. Use the rotary encoder to scroll to **Buzz Fault State** and press the SILENCE button to enter the menu item. Use the encoder to choose the preferred setting and press the SILENCE button to save and return to main menu.

7.6.13 Relay Latching

Use to enable or disable relay latching. Enter test/config mode. Use the rotary encoder to scroll to **Rly# Latching** and press the SILENCE button to enter the menu item. Use the encoder to choose the preferred setting and press the SILENCE button to save and return to main menu.

7.6.14 Relay Hold Off Enable / Disable

Use to enable or disable the ability to hold-off, or clear a relay. Enter test/config mode. Use the rotary encoder to scroll to **Rly# Holdoff** and press the SILENCE button to enter the menu item. Use the encoder to choose the preferred setting and press the SILENCE button to save and return to main menu.

7.6.15 Setting the Relay Hold Off Time

If Relay Holdoff is enabled (see Section 7.6.13 *Relay Holdoff Enable/Disable above*) and the unit has just gone into alarm, pressing the SILENCE button for 5 seconds will clear the buzzer and the relay and will delay the alarm from sounding again until the Hold Off time has completed. The Hold Off duration is global to both relays. The Hold Off feature is disabled by default.

To set the Hold Off Time, enter test/config mode and use the rotary encoder to scroll to **Rly Holdoff Sec**. Press the SILENCE button to enter the menu item. Use the encoder to choose the preferred setting and press the SILENCE button to save and return to main menu.

7.7 Audible Alarm Operation

The DCC-MRI comes with an audible alarm that is mounted on the side of the exterior of the enclosure. It can be enabled or disabled using the jumper on JP4 on the DCC-MRI board. The buzzer is enabled by default.

NOTE: The LPT-A has an internal buzzer as well. It is not controlled by the SILENCE button on the DCC-MRI. We recommend you leave the LPT-A buzzer in the factory default position of 'disabled'.

If the configurable buzzer ON DELAY has been set the delay will begin counting down the moment the set point is reached. If the gas level drops below the set point before the ON DELAY completes the buzzer will not sound.

Pressing the SILENCE button will stop the buzzer or any external audible device the DCC is connected to for a set amount of time. The factory default set amount of time is 5 minutes. If a different set amount of time is required, it will have to be specified at the time of order.

NOTE: If the pump shuts off, caused by a restricted flow and/or the gas reading drops below the alarm setpoint (19.5%), the buzzer will go off.

7.8 Setting Buzzer ON Delay

To set the ON delay for the on board buzzer move the jumper from the IDLE position on JP3 to SET BUZ ON DELAY. The max delay for the buzzer is also 20 minutes and the rotary encoder increments it in 10 second steps. To save the changes, move the jumper back to the IDLE position.

NOTE: The buzzer delay is local to the buzzer and applies regardless of the channel causing the alarm.

7.9 Adjusting Alarm Set Points for CH1

CH1 has one gas alarm set point. All installations of the DCC-MRI will use the factory default alarm set points.

Default set points are as follows:

SENSOR / GAS	MEASUREMENT RANGE	ALARM SET POINT	ALARM DIRECTION
Oxygen (O ₂)	0 - 25 % vol	19.5 % vol	descending

To change the alarm set point first begin by placing the channel select jumper at the bottom of JP3 on CH1 Relay 1. Next, move the other JP3 jumper to SET ALARM 1. Turn the rotary encoder to increase or decrease the level. To save the changes, move the jumper on the SET ALARM position back to IDLE.

NOTE: You can enable or disable the alarm by pressing the SILENCE button while setting the alarm set point.

7.10 Setting Relay ON / OFF Delays

The DCC-MRI comes with configurable ON and OFF delays for Relay 1. In the event of a gas build up in excess of the level set for ALARM 1, RELAY 1 will be triggered and the front LED for CH1 will change from GREEN to AMBER. If an ON DELAY has been set, the LED will change colour and blink but the relay will remain unchanged until the time delay has expired, at which time the relay will “trip” and the LED will change from flashing amber to solid amber. If the gas level falls below the set ALARM level before the delay has finished, the alarm will be cancelled and the delay will be reset for the next alarm.

When the oxygen level returns to normal the RELAY and LEDS will return to normal operation. If an OFF DELAY has been set, the LED will remain in its current colour and the relay will stay tripped for the duration of the RELAY OFF DELAY.

The relay can be configured with an ON DELAY (maximum 20 minutes) and an OFF DELAY (maximum 20 minutes). The default setting is 0 minutes.



When the alarm is triggered, a short press of the SILENCE button will clear the buzzer. The relay can be manually cleared by pressing and holding the SILENCE button for 5 seconds if HoldOff is enabled for the relay. (See Section 7.6.13 *Relay Hold Off*)

If the relay has latching enabled, the alarm will not un-trip until the “SILENCE” button is pressed.

To set a delay, place one jumper on CH1 Relay 1 select jumper is on the correct position for the relay to be configured.

Place the second jumper on JP3 on either SET RLY ON DELAY or SET RLY OFF DELAY depending on the delay you wish to set. The factory set max delay is 20 minutes for both delays on the relay.

Turn the rotary encoder to increase or decrease the level. To save the changes, move the jumper on the SET RLY DELAY position back to IDLE.

NOTE: No delays can be set on CH2 Relay 2.

7.11 Minimum Runtime

The minimum runtime prevents the relay from untripping for a specified amount of time. The relay will remain tripped regardless of the gas level reading or user input. This feature is useful for preventing damage to motorized equipment.

NOTE: The minimum runtime is factory set and cannot be changed in the field.

8 CALIBRATION

CALIBRATION IS DONE ON THE LPT-A, USING THE JUMPERS AND DISPLAY ON THE LPT-A, NOT THE DCC-MRI .

The DCC-MRI is factory calibrated prior to shipping, using 50 feet (15.24m) of tubing attached to the inlet fitting.

8.1 Testing the Vacuum Switch Calibration

The vacuum switch is intended to shut off the pump in the case of a blockage in the inlet tubing. The vacuum switch is factory calibrated prior to shipping and should function properly upon arrival. However, it should be tested prior to using the system.

To test, either cap the end of the inlet tubing or restrict the flow of air. The pump should shut off within 20 seconds. The display should show FLOW ALARM and the buzzer should go off. If the pump doesn't shut off within the specified time, call our service department for technical support.

Toll Free: +1.877.940.8741
Telephone: +1.604.940.8741
email: service@cetci.com

8.2 Calibration Specifications

8.2.1 Gas

- Oxygen sensors require 100% Nitrogen (N₂) for a zero.

Flow Nitrogen over Oxygen sensors before attempting to null adjust them. If the service person is confident of air quality and is careful (do not exhale in the direction of the Oxygen sensor being serviced while span adjusting), Oxygen in the breathing environment can be used as a fairly accurate source of span gas (20.9% volume) “in a pinch”. It is not recommended to use this procedure for all span adjustments of Oxygen sensors.

Calibration span gases should have at least $\pm 5\%$ accuracy and have a current date stamp. Gas generators should have a current dated cell installed.

NOTE: Temperature affects calibration. It is important to ensure the gas is at the appropriate temperature during calibration. If the sensor is being used in an extreme temperature range, calibration should be done in that same temperature range.

8.2.2 Regulators & Flow

If you calibrate the LPT-A using the inlet fitting, a Demand Flow Regulator must be used to avoid drawing down the pump. Remove hose from inlet and attached the hose with the Demand Flow Regulator to the inlet fitting. When using the Demand Flow Regulator, Oxygen gas should be flowed at 1.0 LPM or higher.

8.2.3 Calibration Frequency

- OHS applications: Once every 6 months (OHS: Occupational Health & Safety)

8.2.4 Gas Testing Frequency (Bump Testing)

For the purpose of safety in OHS applications, sensors should be gas tested (bump tested) once every month to confirm response and alarm activation.

NOTE: A calibration label should be applied after every calibration to confirm work performed and the date it was confirmed. If a controller is involved, the alarm set points should be indicated on a label on the front door of the enclosure so anyone working in the environment can be aware.

Required Equipment: Calibration Kit, Calibration gases, Demand Flow regulator

Users can order the Calibration Kit, calibration accessories and / or gases from any CETCI authorized distributor or they can supply their own gas and equipment as long as the gas meets the minimum specifications.

8.3 Calibration Procedure (Done on the LPT-A)

NOTE: Calibration is done to the LPT-A, not the DCC-MRI. All calibration steps refer to the jumpers and display of the LPT-A.

When calibrating an Oxygen sensor, the process is reversed. You need to do the span first and then zero.

Calibration can normally be performed without opening the LPT-A transmitter. A magnetic calibration wand (CETCI part number **CET-MW**) is available from CETCI and is used to touch the LPT-A enclosure at the lower left edge of the vent opening.

A second touch with the calibration wand can be used to cancel the current calibration step. The LPT-A will need to be opened for calibration when any of the following conditions occur:

- The transmitter has not been calibrated for an extended period, which has allowed the sensor aging to reach a level that there appears to be an ambient gas level higher than the transmitter is allowed to correct for.
- The calibration gas concentration to be used is different from that previously set.
- The ambient gas level is higher than considered reasonable. Nitrogen **MUST** be used to zero oxygen sensors.

The calibration procedure of the LPT-A is jumper automated (there are no potentiometers to adjust). Monitoring the calibration with a volt meter at TP1 and TP2 is optional. The range of 0 - 4.0 VDC is equal to the full measurement range of the sensor. O₂ sensor has a standard measurement range of 0 - 25% vol. Therefore, 4.0 VDC = 25% VOL O₂, 3.44 VDC = 20.9% VOL O₂

NOTE: All calibration steps refer to the jumpers and display of the LPT-A.

To achieve calibration, the user must go through the following steps:

Step 1: Set Calibration Gas Level if different from previous. The calibration gas concentration can be changed in the same fashion as the set point:

- Move a jumper from an IDLE position to the CALGAS position
- Rotate the shaft of the encoder, E1, to increase or decrease the calibration gas value.

- The display will show the calibration gas value and a “CALGAS” icon.
- While adjusting the calibration gas value a corresponding voltage will be signaled on the test points TP-1 and TP-2.
- After changing the calibration gas level move the jumper from the CALGAS position back to the IDLE position.
- If the encoder is not rotated for 5 minutes the transmitter will automatically return to normal operation. The jumper will have to be removed and re-installed at the CALGAS position if further adjustment is required.

The factory default calibration gas concentrations are:

SENSOR GAS TYPE	CALIBRATION GAS LEVEL	TP1 - TP2 VOLTAGE
Oxygen (O ₂)	20.9%	3.44 volt

Step 2: Span the Sensor with Oxygen:

- Attach the Demand Flow Regulator to the cylinder of calibration gas and the other end to the inlet fitting on the DCC-MRI. The DCC-MRI cannot be spanned with diffused ambient air because the pump must pull the air across the sensor in order to ensure accurate sensing.
- Make sure the grey adapter plug is firmly installed in the sensor vent of the LPT-A transmitter.
- Open regulator valve fully allowing the calibration gas to flow over sensor for 3 minutes. If no gas is detected after one minute, the transmitter returns to normal operation and the procedure will need to be repeated from Step 2.

NOTE: If an inappropriate concentration of span gas is applied during calibration, calibration may succeed but it does not mean the equipment has been calibrated properly. CETCI is not responsible for improperly calibrated transmitters. Follow manual instructions carefully.

Step 3: Trigger the Calibration by:

- Touching the enclosure of the LPT-A with a magnet wand (below and just left of the gas vent opening) or
- Moving the internal jumper from J7 IDLE position to the CAL position.

The LPT-A will use the last four seconds of gas data to determine the Oxygen span gas level.

If the Span is successful, the LPT-A will show the following message: SPAN ACCEPTED.

Proceed to Step 4.

If the Span was not successful:

- If spanning times out without an acceptable value the display will show 'SPAN FAILED! RECALIBRATE'.
- The 4-20 mA output will signal the failure with 0 mA (0 -10 volt will be 0 volt). This condition can only be resolved by a successful calibration.
- If the calculated sensitivity of the sensor is out of range the display will show 'SPAN FAILED! RECALIBRATE' indicating the sensor cannot be calibrated. You can try to recalibrate, starting from Step 2, to confirm the procedure was followed correctly and this may correct the fault.
- If span fails repeatedly the sensor has either aged beyond its useful life or has otherwise failed, please contact our service department at service@cetci.com.

Step 4: Span Accepted

- Once spanned, the display will show 'FLOW NITROGEN'.
- Disconnect the calibration gas cylinder from the Demand Flow Regulator.

Step 5:

- Attach the Demand Flow Regulator to the bottle of Nitrogen (N_2) 100% vol and keep the other end of the hose on the inlet fitting of the DCC-MRI.
- Ensure that the grey adapter plug is still firmly installed in the LPT-A transmitter's sensor opening.

Step 6:

- Open the regulator valve fully and allow Nitrogen (N_2) gas to flow over the sensor.
- If no Nitrogen (N_2) gas is detected after 2 minutes, the LPT-A transmitter will return to normal operation and the procedure will need to be repeated from Step 2.

Step 7: Wait for Stable Reading

- Once gas flow is detected, the display will show 'WAITING FOR STABLE READING'.
- During this time the TP1 voltage will follow the gas level based on the ideal span of the sensor.
- Zeroing can be cancelled by removing the jumper from the CAL position; return it to the IDLE position. Note that the span value set in Step 4 is not cancelled.
- If zeroing times out without an acceptable value the display will show 'ZERO FAILED! RECALIBRATE'.

Step 8: Possible Override

- If the zero level appears too high (it might have been so long since the last calibration that the sensor has drifted), the display will show "ZERO OUT OF RANGE, OVERRIDE?"
- To cancel calibration, move the jumper from the CAL position back to the IDLE position. The display will show "CALIBRATION CANCELLED" for several seconds then return to normal operation.
- To override, move the second IDLE jumper from its rest position to the OVER / DESC / TEST position.
- If the jumper is not moved to the OVER position within 30 seconds, the calibration will be cancelled and the LPT-A will return to normal mode.
- After using the OVER / DESC / TEST position, the second IDLE jumper should be returned to its rest position.

Step 9: Zeroing Complete

- After the zeroing is completed successfully, the transmitter will display 'CALIBRATION COMPLETE' for several seconds, then return to normal operation.
- Return the jumpers to the IDLE positions.
- If the calculated sensitivity of the sensor is out of range the display will show 'ZERO FAILED! RECALIBRATE' indicating the sensor cannot be calibrated. You can try to recalibrate, starting from Step 2, to confirm the procedure was followed correctly and this may correct the fault.
- If calibration fails repeatedly the sensor has either aged beyond its useful life or has otherwise failed, please contact our service department at service@cetci.com.

NOTE: The LPT-A will automatically return to normal operation after calibration completes (whether passed or failed). If the Nitrogen (N_2) gas is still applied the level will be reflected on the output signal and relay, which could cause the control panel to enter into an alarm state.

To exit calibration at any time, either:

- Touch the enclosure with the calibration wand a second time or
- Remove the jumper from the CAL position and return it to the IDLE position

If the digital multi-meter leads are attached to test points TP-1 and TP-2, the measured voltage will start moving towards the voltage calculated for the applied gas value.

9 ACCESSORIES

9.1 Sample Draw Pump Calibration Kit (p/n: CET-715A-SDP)

The Calibration Kit contains the items necessary for common field and shop calibration. It comes in a durable, hard plastic carrying case. **Gas cylinders are not included in the Kit.** They must be ordered separately from the CETCI factory. Many gases are carried in inventory but not all. Check with any CETCI authorized distributor for availability of specific gas types. **Gas cylinders cannot be shipped from Canada to other countries, including the USA.**



9.2 Magnetic Wand (p/n: CET-MW)

The magnetic wand is used for non-intrusive calibration of the LPT-A.



Strength	0.5 lbs (227 g)
Size	2 5/8" x 1/4" hexagon

10 MAINTENANCE

The DCC-MRI series system requires very little maintenance other than regular calibration of the Oxygen sensor.

Ensure that excess water or dust is not somehow entering the enclosure and physically damaging the circuit board or internal components.

Be sure to regularly check the sample air filter for blockages and/or dirt build up.

Periodically test the inlet air connection for proper pump functioning. Restrict the flow of air by covering the inlet tubing. Make sure the Flow Alarm and buzzer comes on. The pump will shut off if the air flow is restricted for a length of time.

Regular maintenance should include testing for leaks in the inlet tubing. It is recommended that two people conduct this test, one person to cap the end of the inlet tubing and the other to watch the flow meter. If the flow meter shows 0, the tubing is fine. If you see any flow, there is a leak somewhere.

NOTE: The pump will shut off and the buzzer will sound if the inlet hose is capped for a prolonged period of time because you are ultimately simulating a blockage in the line.

11 TROUBLE SHOOTING

11.1 Noisy Pump

4. Check to ensure DCC-MRI enclosure is securely mounted to a flat wall surface.
5. Check to ensure the flow rate has been properly adjusted after sample line and exhaust line (if used) has been installed. A long sample line reduces flow rate and will require adjustment of the flow meter. Too much or too little air flow to the pump will cause the diaphragms to vibrate more creating more noise.
6. Check to ensure pump diaphragm caps are tight. They are shipped from the factory tightly installed but vibration could potentially partially loosen them. If they are loose they could allow the diaphragms to float slightly and that will increase the vibration and create more noise level.
7. Check to ensure pump securing bolts are tight. Vibration over time could have loosened them causing excessive vibration noise from the pump.
8. Check to ensure the white inlet filter is not plugged or partially plugged. This will reduce the air flow through the flow meter and can cause the pump to make more noise.
9. If it is determined that the pump diaphragms need to be replaced they are readily available and easy to replace. Contact your local authorized distributor or CETCI.

11.2 Oxygen Sensor - Low Reading

The oxygen sensor in the LPT-A inside the DCC-MRI has an estimated operating life span of approximately three years. As it ages it will require calibration as do all gas sensors throughout their life. Failure to do so could result in lower than expected Oxygen readings on the display.

At least once per year perform span and zero calibration on the sensor. Refer to *Section 8.4 Calibration Procedure* for more information.

If the unit cannot be out of service it is suggested to log the age of the unit and at approximately 28 - 30 months operation order a replacement Oxygen sensor. Store new sensor in the capsule it is supplied in inside a refrigerator until ready to install. Maximum storage should be 3 - 4 months.

Allow the new sensor to warm up and reach equilibrium with its environment for several hours after installation in the DCC-MRI, before performing a calibration.

Critical Environment Technologies Canada Inc.
Unit 145, 7391 Vantage Way, Delta, BC, V4G 1M3, Canada
Toll Free: +1.877.940.8741
Tel: +1.604.940.8741
Fax: +1.604.940.8745
www.critical-environment.com



DCC-MRI20170614-C