

***Critical Environment Technologies***

**“AST” Series Second Generation  
Analog Transmitters  
for  
Solid-State Sensors  
and  
Catalytic Combustible Sensors**



**INSTALLATION / OPERATION MANUAL**

REV: C JANUARY-16-2006

**Unit 145, 7391 Vantage Way Delta, BC V4G 1M3  
Canada Phone: 604-940-8741 Fax: 604-940-8745 Toll: 1-877-940-8741  
[www.critical-environment.com](http://www.critical-environment.com)**



### **IMPORTANT NOTICE**

READ AND UNDERSTAND THIS OPERATION MANUAL PRIOR TO USING THIS INSTRUMENT.

THIS INSTRUMENT SHOULD BE INSPECTED AND PROGRAMMED BY QUALIFIED AND TRAINED TECHNICIANS.

THIS INSTRUMENT HAS NOT BEEN DESIGNED TO BE INTRINSICALLY SAFE. FOR YOUR SAFETY, DO NOT INSTALL IT IN CLASSIFIED HAZARDOUS AREAS (EXPLOSION-RATED ENVIRONMENTS).

### **DISCLAIMER**

UNDER NO CIRCUMSTANCES WILL CRITICAL ENVIRONMENT TECHNOLOGIES CANADA INC. BE LIABLE FOR ANY CLAIMS, LOSSES OR DAMAGES RESULTING FROM OR ARISING OUT OF THE REPAIR OR MODIFICATION OF THIS EQUIPMENT BY A PARTY OTHER THAN CRITICAL ENVIRONMENT TECHNOLOGIES OR IT'S AUTHORISED SERVICE REPRESENTATIVES, OR BY OPERATION OR USE OF THE EQUIPMENT OTHER THAN IN ACCORDANCE WITH THE PRINTED INSTRUCTIONS CONTAINED WITHIN THIS MANUAL OR IF THE EQUIPMENT HAS BEEN IMPROPERLY MAINTAINED OR SUBJECT TO NEGLIGENCE OR ABUSE. ANY OF THE FORGOING WILL VOID THE WARRANTY.

### **WARRANTY POLICY**

CRITICAL ENVIRONMENT TECHNOLOGIES CANADA INC. WARRANTS THIS INSTRUMENT TO BE FREE FROM DEFECTS IN MATERIALS AND WORKMANSHIP FOR A PERIOD OF TWO YEARS FROM THE DATE OF PURCHASE. THIS INCLUDES ALL SOLID-STATE AND CATALYTIC SENSORS,

THE WARRANTY STATUS WILL BE AFFECTED (VOIDED) IF THE INSTRUMENT HAS NOT BEEN INSTALLED AND MAINTAINED AS PER THE INSTRUCTIONS INDICATED IN THIS MANUAL OR HAS BEEN ABUSED, DAMAGED (ROUGH HANDLING, MECHANICAL DAMAGE, ELECTRICAL SHOCK DAMAGE, ETC.) OR MODIFIED IN ANY WAY. THIS INSTRUMENT IS ONLY TO BE USED FOR THE PURPOSES STATED HEREIN. THIS WARRANTY INDICATES THE FULL EXTENT OF OUR LIABILITY AND WE ARE NOT RESPONSIBLE FOR REMOVAL OR REPLACEMENT COSTS, LOCAL REPAIR COSTS, TRANSPORTATION COSTS OR CONTINGENT EXPENSES INCURRED WITHOUT PRIOR APPROVAL.

CRITICAL ENVIRONMENT TECHNOLOGIES CANADA INC. WILL NOT BE HELD LIABLE FOR INDIRECT, INCIDENTAL OR CONSEQUENTIAL LOSS OR DAMAGE OF ANY KIND TO EQUIPMENT CONNECTED, IN ANY WAY, TO THE EQUIPMENT MANUFACTURED BY US.

THIS WARRANTY COVERS EQUIPMENT AND PARTS SOLD TO USERS ONLY BY AUTHORISED DISTRIBUTORS, DEALERS, AGENTS OR REPRESENTATIVES, AS AUTHORISED AND APPOINTED BY GASONIC INC.

DUE TO ONGOING RESEARCH, DEVELOPMENT AND PRODUCT TESTING, THE MANUFACTURER RESERVES THE RIGHT TO CHANGE SPECIFICATIONS WITHOUT NOTICE. THE INFORMATION CONTAINED HEREIN IS BASED ON DATA CONSIDERED ACCURATE. HOWEVER, NO WARRANTY IS EXPRESSED OR IMPLIED REGARDING THE ACCURACY OF THIS DATA.

ALL GOODS MUST BE SHIPPED TO THE MANUFACTURER BY PREPAID FREIGHT. ALL RETURNED GOODS MUST BE ACCOMPANIED BY AN RMA NUMBER.

## **SERVICE POLICY**

CRITICAL ENVIRONMENT TECHNOLOGIES MAINTAINS AN INSTRUMENT SERVICE FACILITY AT THE FACTORY. SOME CRITICAL ENVIRONMENT TECHNOLOGIES DISTRIBUTORS / AGENTS ALSO HAVE REPAIR FACILITIES, HOWEVER, CRITICAL ENVIRONMENT TECHNOLOGIES ASSUMES NO LIABILITY FOR SERVICE PERFORMED BY ANYONE OTHER THAN CRITICAL ENVIRONMENT TECHNOLOGIES' PERSONNEL. REPAIRS ARE WARRANTED FOR 90 DAYS AFTER DATE OF SHIPMENT (SENSORS, PUMPS AND BATTERIES HAVE INDIVIDUAL WARRANTIES). SHOULD YOUR INSTRUMENT REQUIRE NON-WARRANTY REPAIR, YOU MAY CONTACT THE DISTRIBUTOR FROM WHOM IT WAS PURCHASED OR YOU MAY CONTACT CRITICAL ENVIRONMENT TECHNOLOGIES DIRECTLY.

IF CRITICAL ENVIRONMENT TECHNOLOGIES IS TO DO THE REPAIR WORK, YOU MAY SEND THE INSTRUMENT, PREPAID, TO CRITICAL ENVIRONMENT TECHNOLOGIES , UNIT 145, 7391 VANTAGE WAY, DELTA, B.C. V4G 1M3, ATTN: SERVICE DEPARTMENT. ALWAYS INCLUDE YOUR ADDRESS, TELEPHONE NUMBER, CONTACT NAME, SHIPPING / BILLING INFORMATION AND A DESCRIPTION OF THE DEFECT AS YOU PERCEIVE IT. YOU WILL BE CONTACTED WITH A COST ESTIMATE FOR EXPECTED REPAIRS, PRIOR TO THE PERFORMANCE OF SERVICE WORK. FOR LIABILITY REASONS, CRITICAL ENVIRONMENT TECHNOLOGIES HAS A POLICY OF PERFORMING ALL NEEDED REPAIRS TO RESTORE THE INSTRUMENT TO FULL OPERATING CONDITION.

PRIOR TO SHIPPING EQUIPMENT TO CRITICAL ENVIRONMENT TECHNOLOGIES CONTACT OUR OFFICE FOR AN RMA # (RETURNED MERCHANDISE AUTHORIZATION). ALL RETURNED GOODS MUST BE ACCOMPANIED WITH AN RMA NUMBER.

PACK THE EQUIPMENT WELL (IN IT'S ORIGINAL PACKING IF POSSIBLE), AS WE CANNOT BE HELD RESPONSIBLE FOR ANY DAMAGE INCURRED DURING SHIPPING TO OUR FACILITY.

## **MANUAL REVISIONS**

ALL INFORMATION CONTAINED IN THIS MANUAL IS BELIEVED TO BE TRUE AND CORRECT AT THE TIME OF PRINTING. HOWEVER, AS PART OF IT'S CONTINUING EFFORTS TO IMPROVE IT'S PRODUCTS AND THEIR DOCUMENTATION, CRITICAL ENVIRONMENT TECHNOLOGIES RESERVES THE RIGHT TO MAKE CHANGES AT ANY TIME WITHOUT NOTICE. REVISED COPIES OF THIS MANUAL CAN BE OBTAINED BY CONTACTING CRITICAL ENVIRONMENT TECHNOLOGIES CANADA INC.

## INDEX

SECTION	DESCRIPTION	PAGE
	NOTICE AND WARRANTY POLICY	3-4
	INDEX	5
1.0	INTRODUCTION	6
2.0	GENERAL SPECIFICATIONS	6-7
3.0	PVC ENCLOSURE PHOTO	8
3.1	POLYCARBONATE ENCLOSURE PHOTO	9
4.0	INSTALLATION	10
4.1	MOUNTING HEIGHTS	10
4.2	PVC ENCLOSURE INTERIOR AND MOUNTING HOLES	11
4.3	WATER TIGHT ENCLOSURE INTERIOR AND MOUNTING HOLES	12
5.0	WIRING THE TRANSMITTER	13-14
6.0	COMPONENT IDENTIFIER	13
7.0	TRANSMITTER OPERATION	15-16
8.0	JUMPER SETTINGS PHOTO	17
9.0	ADJUSTING ALARM SET POINT (RELAY OPTION ONLY)	17-18
10.0	CALIBRATING SENSORS	18
10.1	CALIBRATION SPECIFICATIONS	18-19
10.3	CALIBRATION PROCEDURE	19
10.4	SETTING SPAN GAS VALUE	19
10.5	CALIBRATING THE NULL (ZERO) VALUE	19-20
10.6	CALIBRATING THE SPAN VALUE	20-21
11.0	CALIBRATING THE ANALOG OUTPUT	21-22
12.0	OPTIONS FOR AST SECOND GENERATION TRANSMITTERS	23
13.0	ACCESSORIES	23

## 1.0 INTRODUCTION

The AST second generation series transmitters are rugged, user-friendly, configurable analog transmitter gas detectors for use in non-hazardous (non-explosion rated) environments for commercial HVAC and light industrial use. They can be configured for either solid-state or catalytic sensor elements.

A standard transmitter provides a tri-colour LED indicating light for power, fault condition, alarm (option with one dry contact relay), analog output signal, optional LED digital display and other enclosure options.

A selection of solid-state MOS (Metal Oxide Semiconductor) sensors, or catalytic combustible sensors are available for use with this gas detector. The sensors utilized in this device are accurate enough to measure to Occupational Health & Safety hazardous levels for combustible gases and toxic levels for refrigerant gases.

**Note:** The AST analog transmitters operate by diffusion. If a sample draw system is desired, consult a CETCI authorized distributor or the factory for details.

## 2.0 GENERAL SPECIFICATIONS

Physical:	<p><u>Standard pvc enclosure:</u> <i>(Solid-state sensors only)</i></p> <p>a) Dimensions: 6.5" (165 mm) wide X 4.43" (113 mm) high X 2.54" (65 mm) deep</p> <p>b) Weight: 20 ounces</p> <p><u>Optional water / dust tight enclosure:</u> <i>(Standard for catalytic sensors)</i> <i>(Optional for solid-state sensors)</i></p> <p>a) Dimensions: 4.92" (125 mm) wide X 4.92" (125 mm) high X 2.92" (75 mm) deep</p> <p>b) Weight: 16 ounces</p>
Construction:	<p><u>Standard enclosure:</u> Rugged PVC with hinged, secured door and Lexan door label. Door has 1/2" overlap making it drip-proof</p> <p><u>Water/Dust tight enclosure:</u> Rugged polycarbonate with hinged, secured door and Lexan door label</p>
Power:	12VAC to 30VAC or 16VDC to 30VDC
Current draw:	80 to 120 mA
Relay:	One only S.P.D.T. dry contact relays rated 2 amps @ 30 VAC
Indicators:	<p>a) One tri-colour LED: Green = power, Amber = Low alarm, Red = High alarm, Flashing Red = Fail</p> <p>b) Amber colored, LED light, relay coil status indicators (internal) <u>Note:</u> Only supplied if relay option has been selected</p> <p>c) 4-20 mA "open loop" indicator (red LED) for remote transmitter</p>

## 2.0 GENERAL SPECIFICATIONS, CONT'D.....

- Options:
- a) LED digital display (3.5 digits)
  - b) Relay
  - c) Water/dust tight enclosure
  - d) Splash guard (water tight controller and transmitter enclosure only)
- Sensors:
- a) Catalytic pellistor
  - b) Solid-state MOS (Metal Oxide Semiconductor)
- Ranges:
- a) Catalytic: 0-100% LEL of target combustible gas or vapour
  - b) Solid-state combustible: 0-50% LEL
  - c) Solid-state refrigerant: 0-2000 ppm
- Life span:
- a) Catalytic: Approximately 5 years in clean, ambient conditions
  - b) Solid-state combustible: Approximately 5 to 8 years in clean, ambient conditions
  - c) Solid-state refrigerant: Approximately 5 years plus in clean, ambient conditions
- Resolution:
- a) Catalytic: 1% LEL
  - b) Solid-state combustible: 1% LEL
  - c) Solid-state refrigerant: 2 ppm
- Temperature: -20°C to +40°C (-4°F to +104°F)
- Humidity: 0-90% non-condensing
- Response:
- a) Catalytic: '90 from air to 50% LEL = <12 seconds
  - b) Solid-state combustible:
  - c) Solid-state refrigerant:
- Warm up:
- a) Circuit: The microprocessor circuit has a 2-minutes warm up delay
  - b) Catalytic: 1-hour for best performance (maximum accuracy)
  - c) Solid-state: 24 hours for best performance (maximum accuracy)

3.0 PVC ENCLOSURE PHOTO

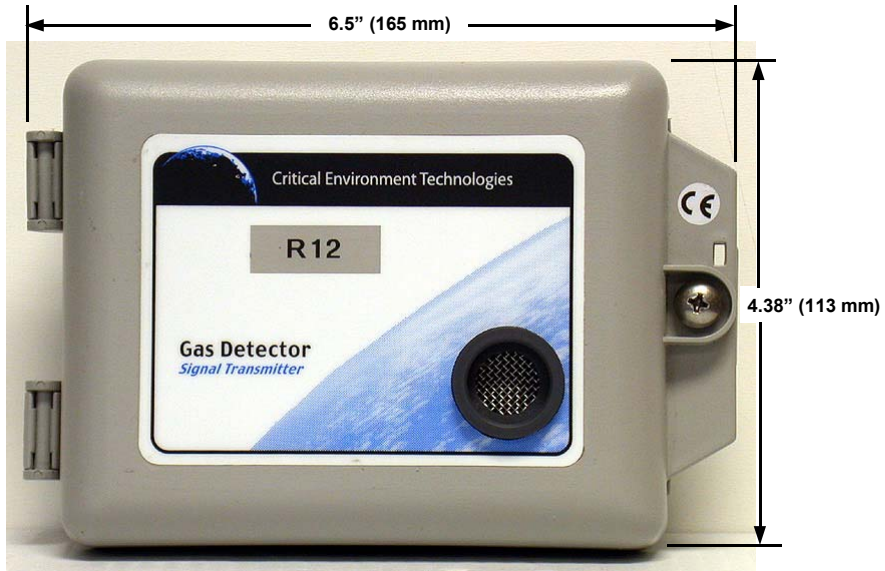

PHOTO-1



PHOTO-2



3.1 POLYCARBONATE ENCLOSURE PHOTO

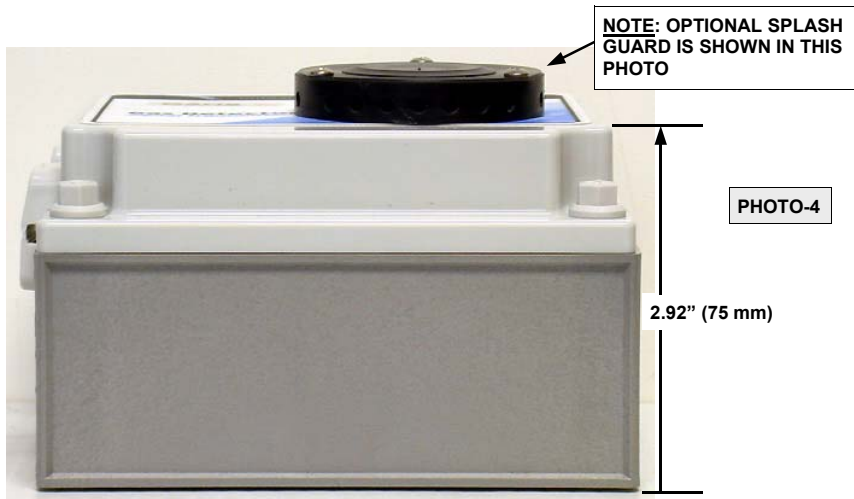
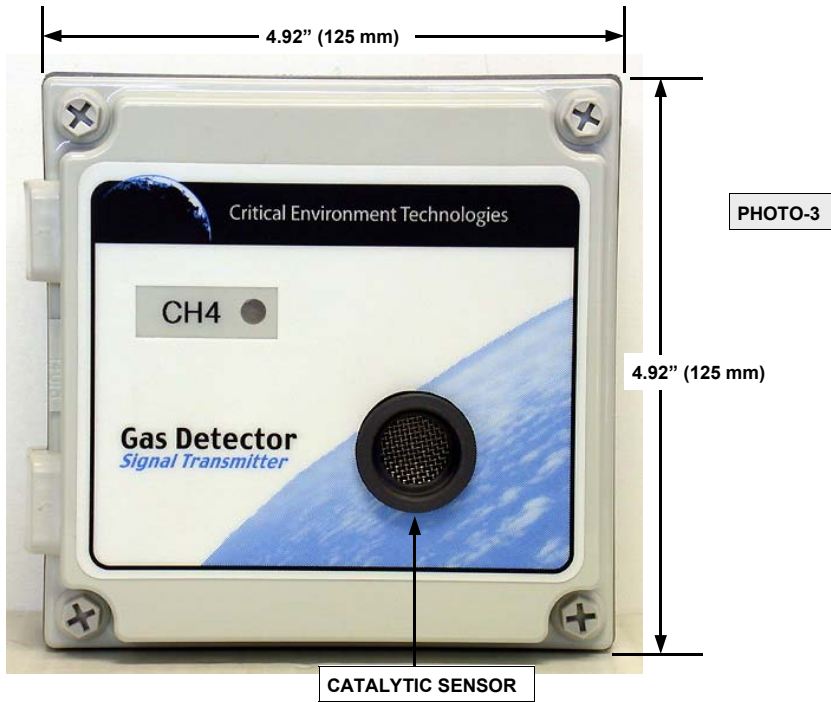

#### 4.0 INSTALLATION

The AST should be installed on a flat vertical surface with the sensor pointing outwards in a clean, dry environment. If the MAC-II is to be installed in a potentially wet environment, the optional water tight enclosure should have been selected. This reference refers to the standard, general purpose pvc enclosure. Four 3/8" diameter mounting holes are provided in the enclosure base for securing the AST to the wall. Do not block the front of the enclosure as this is where the MAC sensor is situated and where it monitors the air for the target gas.

The water tight enclosure must be installed with the mounting screws passing through the same openings that accommodate the four door securing screws. This ensures the mounting screws are outside of the door gasket and confirms a water tight installation.

Five conduit entry points are provided for the pvc enclosure. All are in the enclosure base. One in the rear of the base. One in the top edge and one in the bottom edge and two at the right side. Reference photos on preceding pages. No conduit entry points are provided for the water tight enclosure. The reason is the installer may not want one where we would place it and this would result in unnecessary openings into this enclosure.

**Note-1:** When mounting either enclosure, allow enough room to enable the end user to open the door fully to access the internal adjustments.

**Note-2:** Use caution when drilling holes in the water tight enclosure for conduit entry so as not to damage the circuit board inside. Use liquid tight conduit hubs wherever conduit enters the water tight enclosure. Failure to do so creates a leak path. Water running down the conduit enters the interior of the enclosure and could corrode the circuit board. *This is not covered under warranty.*

The door of the pvc enclosure can be easily removed to facilitate installation of the base. Simply grasp the lid with one hand, being careful not to make contact with any of the internal components (circuit board), grasp the base with your other hand. Tug on the base, pulling it towards you. The section of the hinges located on the base should "snap" apart from the part of the hinges located on the door.

After installation, simply locate the lid hinges over the installed base hinges and pull toward you. The hinges should easily "snap" back into place.

The pvc enclosure has one screw securing the door to the base for electrical safety and provides an opening to allow the user to apply a padlock if they desire the controller to be locked. See photo reference on preceding pages.

The pvc enclosure, by design of the substantially overlapping door, is drip-proof. It is not water tight or dust tight. An optional water / dust tight enclosure is available.

#### 4.1 MOUNTING HEIGHTS

Some combustible gases such as Methane (CH<sub>4</sub>) are lighter than air, therefore the sensor/transmitter should be installed on or near the ceiling. Some combustible gases and all vapours are heavier than air, therefore the sensor/transmitter should be installed with the sensor opening at 6" from the floor.

Although most refrigerants (Freons) are heavier than air some applications may be better suited to a slightly higher mounting height for refrigerant sensors.

## 4.2 PVC ENCLOSURE INTERIOR AND MOUNTING HOLES

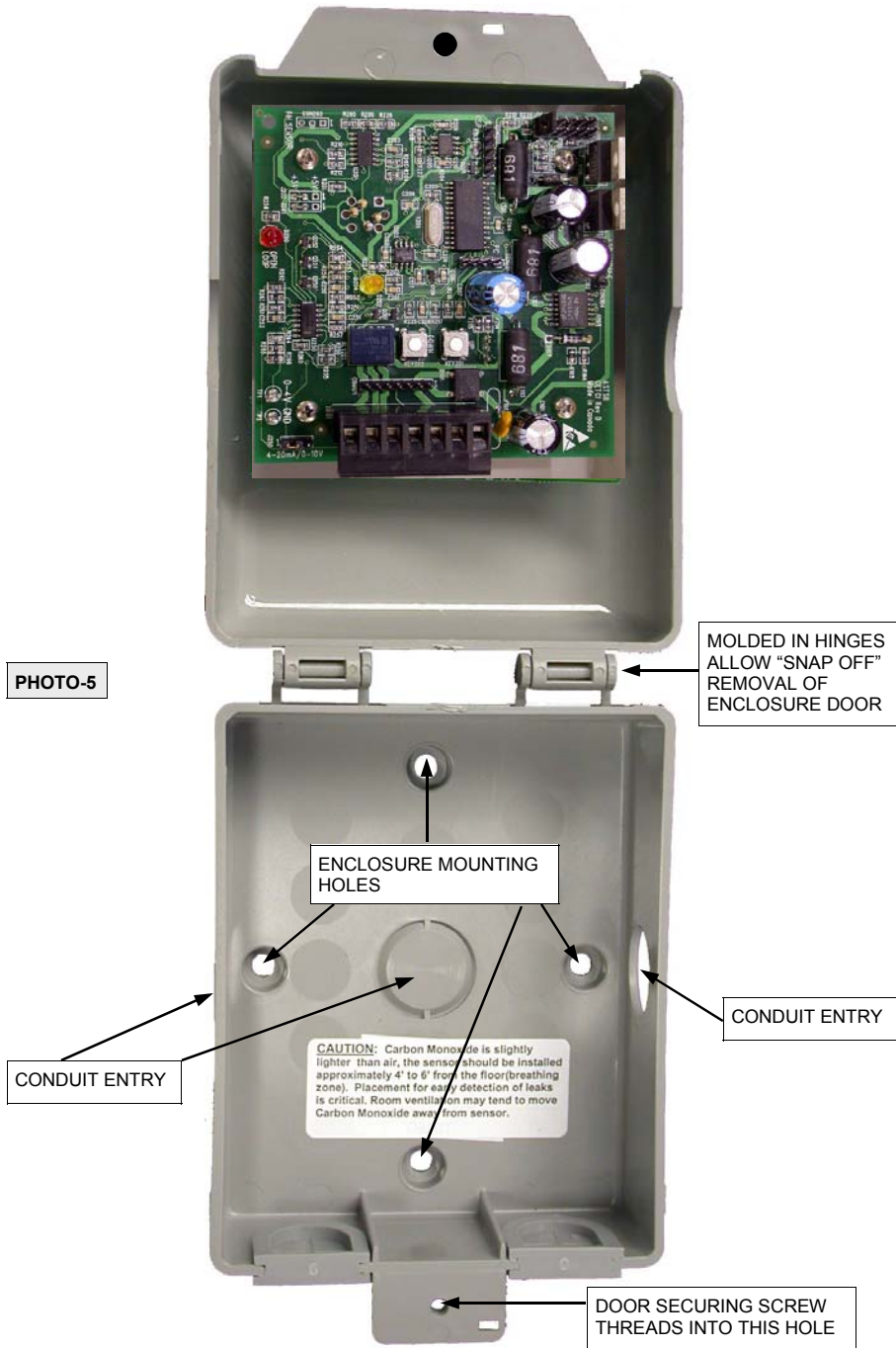

### 4.3 ENCLOSURE INTERIOR AND MOUNTING HOLES

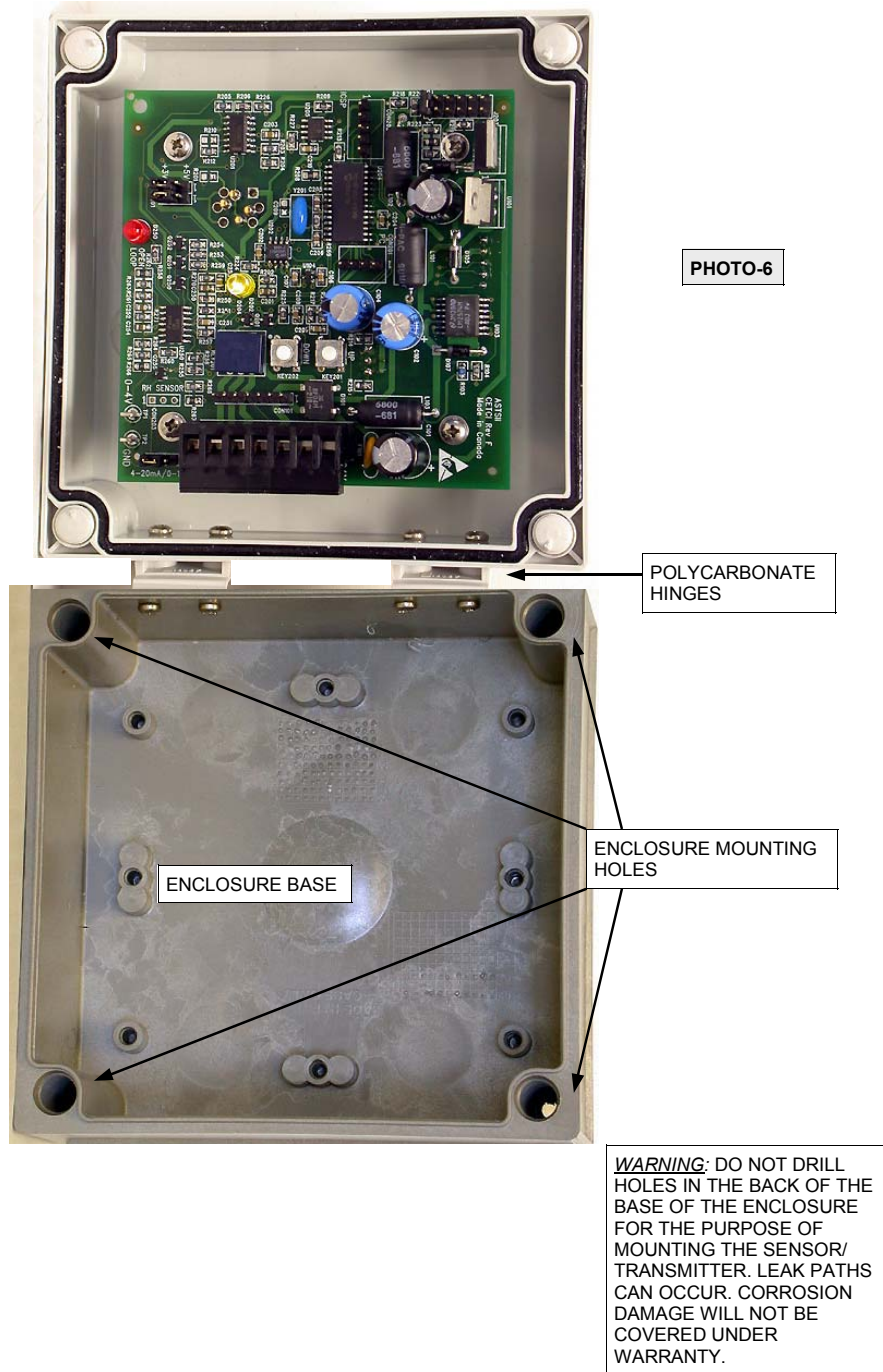

**5.0 WIRING THE TRANSMITTER**

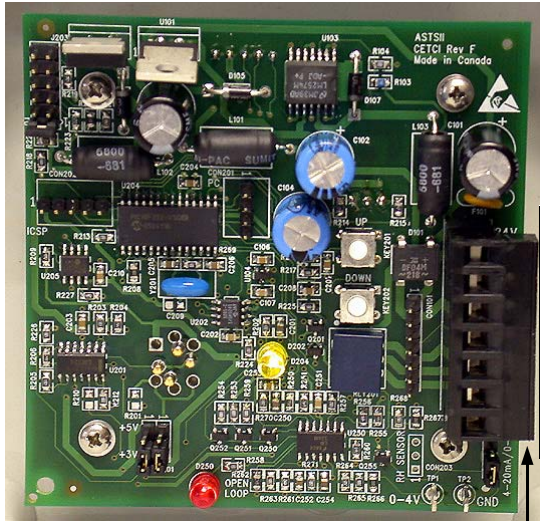

**PHOTO-7**

24VAC  
 24VAC or 24VDC POSITIVE  
 24VDC NEGATIVE  
 SIGNAL  
 N/C - LOW RELAY (DRY CONTACT)  
 COM - LOW RELAY (DRY CONTACT)  
 N/O - LOW RELAY (DRY CONTACT)

THE AST WIRING TERMINAL IS A "PLUGGABLE" TYPE ALLOWING EASIER INSTALLATION OF WIRE. THE PHOTO ABOVE INDICATES THE WIRING TERMINAL PLUGGED IN. THE PHOTO BELOW INDICATES THE WIRING TERMINAL UNPLUGGED.

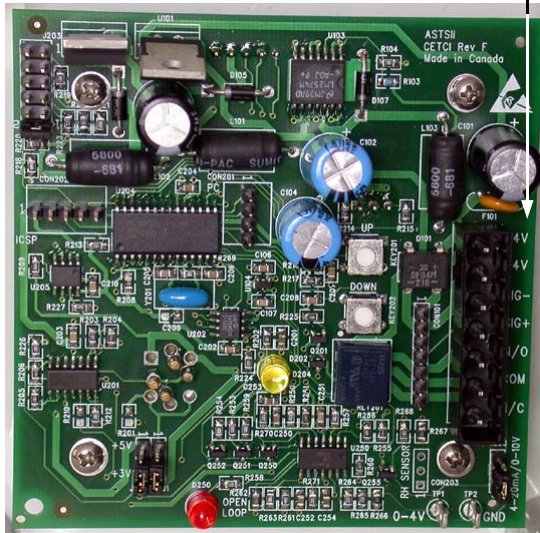

**PHOTO-8**

**PLUGGABLE WIRING TERMINAL**



**PHOTO-9**

## 5.0 WIRING THE TRANSMITTER, CONT'D.....

If the installer is powering the AST with 24VAC, both VAC wires should be connected to the terminal "one" and terminal "two", from the top down. If the installer is powering the AST with 24VDC, the "positive" (red) wire should be connected to terminal "two" and the negative (black) wire should be connected to terminal "three". The signal wire is always connected to terminal "four". Reference photos on preceding page.

Terminals "five", "six" and "seven" are used only if the relay option has been supplied. Double check the relay ratings in the specifications section 2.0 of this manual before operation. For normal operation, the relay control wiring should be connected to "N/C" and "COM" (failsafe operation).

**Note-3: DO NOT USE SOLID-CORE WIRE AT THE WIRING TERMINAL STRIP.** The memory in solid-core wire can pull a soldered terminal strip completely off a circuit board.

The AST series analog transmitter is a low voltage powered device. Any application of operating voltages higher than indicated in the specification may result in damage. Double check wiring connections prior to powering the transmitter. Damage from incorrect wiring connections or from too much voltage applied are not covered under warranty.

System power: *The main wiring terminal strip on the AST circuit board can be unplugged for easier wiring installation. Grasp the two sides of the terminal strip and lift upward with a slight side to side rocking motion.* Reference photos on the preceding page.

## 6.0 COMPONENT IDENTIFIER

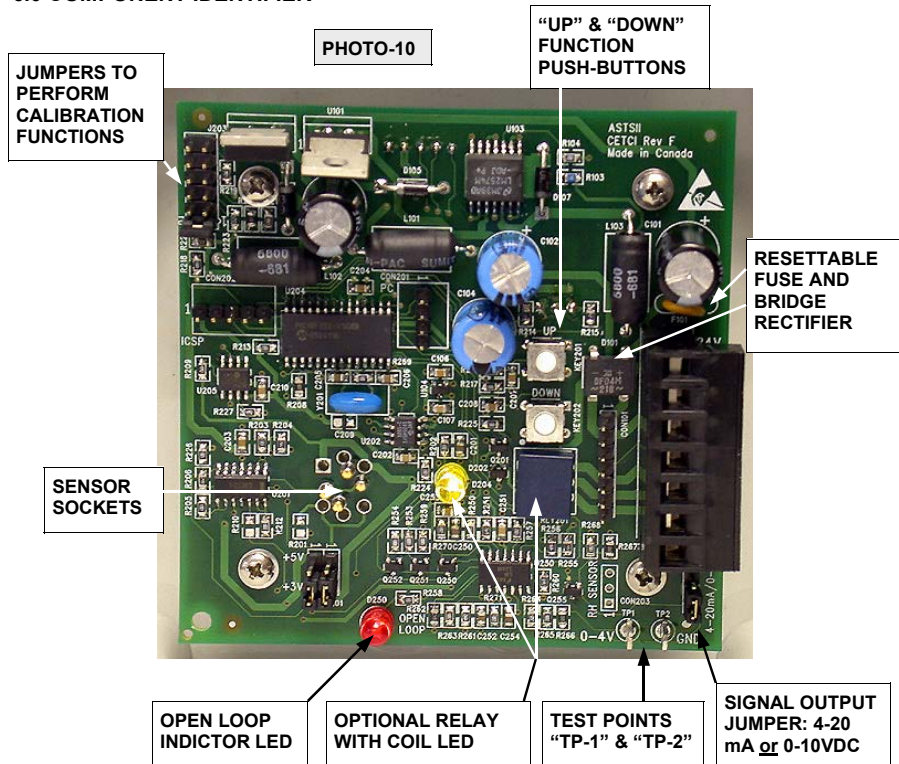

## 7.0 TRANSMITTER OPERATION

After installation, double check wiring prior to applying power to the AST transmitter. **Remember**, these are low voltage devices. After power up, the tri-colour outer LED will “flash” green indicating the system is in a warm-up period. During the warm up period, the signal output from the AST is fixed at 4.0 mA. If the digital display option has been fitted, the LED display will indicate a scrolling decimal “.....” until the warm up times out. If the relay option has been selected, the relay is not activated during warm up. The AST second generation analog transmitter for catalytic and solid-state sensors has been programmed with a 5-minute warm up period. After the warm up times out, the signal output and digital display (if this option has been supplied) will indicate current gas readings if any.

If the relay option has been supplied, it will have a factory preset alarm set point (this can easily be changed in the field). In a non-alarm state, the tri-colour outer LED will be illuminated green and the amber relay coil inner LED will be illuminated, if the relay option has been supplied. The illuminated relay coil LED indicates to the user that the relay coil is energized. The relay option on the AST board has been designed to operate in a fail-safe manner, meaning that the relay coil is energized in non-gas-alarm state and de-energize when a gas alarm is indicated. As noted in section 5.0, the device to be controlled should be connected to the “N/C” (normally closed) and “COM” (common) terminals. In the event of a sensor failure, anything controlled by the relay is activated continuously until the fail condition has been corrected. **Note:** The installer has the option of wiring to “N/O” (normally open) and “COM” (common) terminals, however it must be noted that the system will no longer be operating in a fail-safe state. A sensor failure will then simply activate the front LED to change to flashing red.

### Detecting Gas

Upon detection of the presence of target gas, the signal output increases to a value equal to the amount of gas being detected by the sensor. If the LED display option has been supplied, this value will be displayed. If the concentration of gas is above the preset alarm threshold, the tri-colour outer LED changes to a red colour, the alarm relay de-energizes and the amber relay coil LED goes out.

As the detected gas level subsides, the output signal will decrease again to a value equal to anything being detected by the sensor and this will be indicated on the LED display if this option has been fitted. The relay will automatically reset after the signal drops below the set point value.

### Failure

In the event of a failure, the tri-colour outer LED will flash red, the relay will de-energize, the relay coil LED will go out and the output signal will drop below 4.0 mA. A failure can consist of a burned out sensor element (solid-state or catalytic), a failed or damaged component on the circuit board or a wiring related problem.

### Open Loop

The AST circuit board has been fitted with a red LED located near the bottom centre of the circuit board. This is an “open loop” indicator and has been designed as a quick trouble shooting device. If the 4-20 mA signal loop has not been connected properly or has been damaged in some manner between the analog transmitter and the device to which it is sending its signal output, this LED illuminates. At this point, the wiring should be inspected for potential problems.

## 7.0 TRANSMITTER OPERATION, CONT'D.....

### Other Warnings

Notification of calibration: All sensors require calibration to maintain accuracy and best performance. This is a visual warning and has been factory set at either 6 or 12 months. At 6 or 12 months, the outer green LED will flash at 0.2 second intervals for 30 seconds every hour to indicate to the user that the sensor is due for re-calibration. If the transmitter has been supplied with the LED digital display option, it will scroll and indicate "CALI" and "DUE" during this period. The end user can disable this feature for 1 month by depressing both the "up" and "down" push buttons simultaneously. After 1 month, the visual reminder will reactivate and once again, the user has the option of disabling this function again for 1 month or having the instrument calibrated. If the system is recalibrated, the system timer is automatically reset for another 6 or 12 months (or whatever the factory default setting was at the time of ordering). During the short calibration warning state, other normal functions are temporarily disabled until the detector is calibrated or the notification function has been temporarily disabled.

### Sensors

Solid-state Refrigerant: These sensors are not gas specific and will respond to a fairly wide range of interfering gases and vapours. They are temperature and humidity compensated to reduce drift in environments where the temperature and humidity changes regularly.

Solid-state Combustible: These sensors are not gas specific but do not suffer from false alarms from interfering gases very often because of the extremely high measuring range they have been calibrated for.

Catalytic Combustible: These sensors are specific to combustible gases and vapours. They are also temperature compensated.

All of these sensor types require lengthy warm up and stabilization time after installation. Do not perform any calibration functions until the sensors have been operating for at least 24 hours.



## 8.0 JUMPER SETTINGS PHOTO

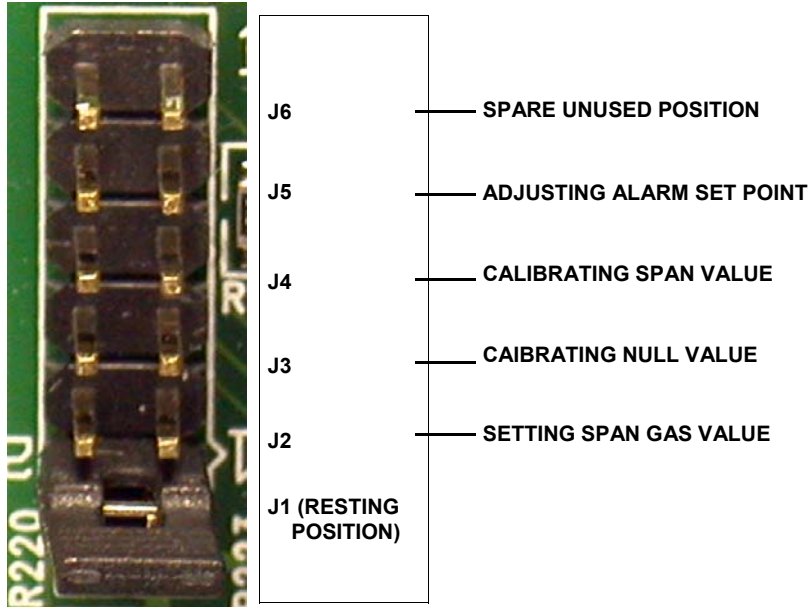

PHOTO-11

## 9.0 ADJUSTING ALARM SET POINT (FOR RELAY OPTION ONLY)

If the optional relay has been supplied, the alarm set point on the second generation AST analog transmitter can be field adjusted. This a voltage adjustment over the range of 0 - 4 VDC. This range is equal to the full measurement range of the installed sensor. **Eg.** Catalytic combustible sensor has a standard measurement range of 0 -100% LEL. Therefore 4.0 VDC = 100% LEL. Prior to adjusting the alarm set point, calculate the voltage value required using the following formula.

$$\frac{\text{DESIRED SET POINT}}{\text{SENSOR RANGE}} = \% \text{ OF RANGE}$$

$$\text{EG. } \frac{10\% \text{LEL}}{100\% \text{LEL}} = 0.1\% \text{ OF RANGE}$$

10% OF 4.0 VDC = 0.4 VDC Therefore the required voltage setting to achieve an alarm set point of 10% LEL is 0.4 VDC.

Gas alarm set point adjustment

1) Move the jumper to **J5** position. The green outer LED will flash once within 2-seconds for confirmation. The system is now waiting for the user to set the desired value.

## 9.0 ADJUSTING ALARM SET POINT (FOR RELAY OPTION ONLY), CONT'D.....

- 2) Attach digital multi-meter leads to test points TP-1 and TP-2 (digital photo #6 page-13). Alternatively, if the optional LED digital display has been fitted, read the value indicated on the display.
- 3) Using the "UP" or "DOWN" push-buttons, achieve the calculated voltage reading on the multi-meter. Reference digital photo # 6 on page 13 for location of push-buttons.
- 4) Move the jumper back to it's resting position (J1). At this time the new value is saved and the green LED flashes once for confirmation.

## 10.0 CALIBRATING SENSORS

Calibration Frequency:      a) Parking garage detectors: Once every 12 months  
   b) OHS applications: Once every 6 months  
   (OHS: Occupational Health & Safety)

Gas Testing Frequency: For the purposes of safety in OHS applications, sensors should be gas tested (bump tested) once every month to confirm response. A manual test using span gas is recommended for all sensors.

**Note:** A calibration label should be applied after every calibration to confirm work performed and the date it was confirmed. If a controller is involved, the alarm set points should be indicated on a label on the front door of the enclosure so anyone working in the environment will be aware.

Required Equipment:

- Digital multi-meter
- Potentiometer screw driver (for AST current generation transmitters)
- Calibration kit
- Calibration gases

Users can order the calibration kit, calibration accessories and/or gases from any CETCI authorized distributor or they can supply their own gas and equipment as long as the gas meets the minimum specifications indicated on the next page.

## 10.1 CALIBRATION SPECIFICATIONS

Gas: Calibration span gases should be at least +/- 5% accuracy and have a current date stamp. Gas generators should have a current dated cell installed. Service personnel should flow zero emissions air or Oxygen to before attempting to null adjust toxic gas sensors. Nitrogen (N<sub>2</sub>) should not be substituted for zero air because all solid-state and catalytic sensors require at least a small volume of Oxygen to operate. Calibration will be inaccurate.

### 10.1 CALIBRATION SPECIFICATIONS, CONT'D.....

Regulators & Flow: Calibration gases that are lighter than or the same weight as air (CH<sub>4</sub>, H<sub>2</sub>, etc.) should be flowed at 0.5 LPM. Gases heavier than air (C<sub>3</sub>H<sub>8</sub>, etc.) should be flowed between 0.5 and 1.0 LPM. Fixed flow regulators provide more accuracy. Gases should be flowed over the sensor for at least 3 minutes. All cylinder regulators supplied by CETCI use a fixed flow orifice.

The proper calibration adapter should be utilized to allow the gas to properly diffuse around the sensor. They are available from CETCI.

A humidification chamber must be utilized for all solid-state sensors. This is also available from CETCI.

### 10.3 CALIBRATION PROCEDURE

The calibration procedure within the second generation AST transmitter is push-button automated (there are no potentiometers to adjust). To achieve calibration the user must first tell the AST what concentration of span gas he is going to flow over the sensor. Within the transmitter, calibration is a voltage setting. The range of 0-4 VDC is equal to the full measurement range of the sensor. **Eg.** A catalytic combustible gas sensor has a standard measurement range of 0 -100% LEL. Therefore 4.0 VDC = 100% LEL. Prior to attempting to calibrate, determine or calculate the voltage value required. Use the following formula to calculate the voltage required.

$$\frac{\text{CALIBRATION SPAN GAS VALUE}}{\text{OF RANGE SENSOR RANGE}} = \% \text{ OF RANGE} \qquad \text{EG. } \frac{1000 \text{ ppm}}{2000 \text{ ppm}} = 50\%$$

50% OF 4.0 VDC = 2.0 VDC Therefore the required voltage setting to calibrate with 1000 ppm refrigerants is 2.0 VDC.

### 10.4 SETTING SPAN GAS VALUE

- 1) Move the jumper to **J2** position. The green outer LED flashes once for confirmation. The system is now waiting for the user to set the desired value.
- 2) Attach digital multi-meter leads to test points TP-1 and TP-2 (digital photo #6 page-13). Alternatively, if the optional LED digital display has been fitted, read the value indicated on the display.
- 3) Using the "UP" or "DOWN" push-buttons, achieve the calculated voltage reading on the multi-meter.
- 4) Move the jumper back to it's resting position (J1). At this time the new value is saved and the outer LED flashes once for confirmation.

### 10.5 CALIBRATING THE NULL (ZERO) VALUE

- 1) Attach regulator to cylinder of zero air.

## 10.5 CALIBRATING THE NULL (ZERO) VALUE, CONT'D.....

2) Insert the calibration adapter into the sensor opening in the front of the enclosure door. Use a slight twisting motion as you gently push the calibration adapter into the sensor opening. If the calibration adapter is hard to insert, moisten the o'ring slightly then try re-inserting it. If the transmitter has been fitted with an optional splash guard, remove the plastic plug from the centre of the splash guard to gain access to the sensor opening. To remove the plastic plug, push inward at the centre of the plug until the edges lift slightly then slip a small flat blade screwdriver under and pop the plug off.

3) Open regulator valve fully and allow zero air to flow over sensor.

4) Move the jumper to **J3** position. The tri-colour outer LED will change to a steady amber colour. The system now waits 30 seconds to ensure the user is flowing zero air.

5) The AST then enters a 90 second count down during which time it adjusts the null value. If the user wishes to view this, attach meter leads to test points TP-1 and TP-2 (digital photo #6 page-13). The meter will show "0" then climb to a higher value VDC then slowly descend back to "0" indicating the AST has null adjusted the circuit. Alternatively, if the optional LED digital display has been fitted, it will indicate "CAL" "NULL" and the gas value scrolling from one to the other and back. Once the count down is finished, the outer LED changes back to green indicating the procedure is complete.

6) Before removing the zero air, move the jumper back to it's resting position (J1) and the new value is saved.

**Note:** If the user attempts to null adjust the sensor without applying zero air and the sensor detects a background gas of more than +/- 1% of "0", the amber LED flashes to advise the user that it is out of tolerance. This is unsafe and would produce inaccurate readings. If after flowing zero air, the circuit does not settle within the 1% tolerance value, the user can continue the null procedure by performing an unlock function. To achieve this, push both the "UP" and "DOWN" buttons together. The null procedure will then continue.

## 10.6 CALIBRATING THE SPAN VALUE

1) Attach regulator to cylinder of span gas.

2) Insert the calibration adapter into the sensor opening in the front of the enclosure door. Use a slight twisting motion as you gently push the calibration adapter into the sensor opening. If the calibration adapter is hard to insert, moisten the o'ring slightly seal then try re-inserting it.

3) Open regulator valve fully and allow span gas to flow over sensor.

4) Move the jumper to **J4** position. The tri-colour outer LED will change to a steady amber colour. The system now waits 30 seconds to ensure the user is flowing span gas.

5) The AST then enters a 180 second count down during which time it adjusts the circuit to the span value which was set earlier (see "setting span gas value"). If the user wishes to view this, attach meter leads to test points TP-1 and TP-2 (digital photo #6 page-13). The meter will show an increasing voltage indicating the AST sensor is responding to the span gas and the circuit is being adjusted for accuracy. Alternatively, if the optional LED digital display has been fitted, read the value indicated on the outer digital display. Once the count down is finished, the outer LED changes back to green indicating the procedure is complete.

## 10.6 CALIBRATING THE SPAN VALUE, CONT'D.....

6) Before removing the span gas, move the jumper back to it's resting position (J1) and the new value is saved.

**Note:** If the user attempts to span adjust the sensor without applying span gas or the proper value of span gas, the sensor will produce a response that is outside of the circuit preset tolerance value. The amber LED flashes to advise the user that it is out of tolerance. This is unsafe and would produce inaccurate readings. If after flowing span gas, the circuit does not settle within the 20% tolerance value, the user can continue the null procedure by performing an unlock function. To achieve this, push both the "UP" and "DOWN" buttons together. The span procedure will then continue.

## 11.0 CALIBRATING THE ANALOG OUTPUT

*The following procedures are not required to be performed as a part of normal maintenance. They are usually performed on new circuit boards before they leave our factory or if someone doubts the accuracy of the 4-20 mA output signal. Device Master terminal software program and a special interface cable are both required to perform these calibrations.*

**Note:** Device Master terminal software program can be purchased from CETCI but only after a technician from your company has been trained and certified in the use of it. After the initial purchase, CETCI provides free up dates.

*To achieve these calibrations, the AST second generation circuit must first be "un-initialized" using the Device Master program. Remove the jumper from it's resting position (J1). After performing the uninitializing procedure, the circuit, proceed with the following steps:*

**4 mA OUTPUT SIGNAL CALIBRATION:** \*Ensure the output selection jumper is set to the 4-20 mA position (see photo #6 on page 13 for position).

- 1) Connect a digital multi-meter in series with the 4-20 output and set it to DC current.
- 2) Put the jumper onto "J1" position. Within 2-seconds, the tri-colour outer LED starts flashing amber for confirmation and the AST is now waiting for 4 mA calibration procedure to take place.
- 3) Use the "UP" and "DOWN" push-buttons to adjust the meter reading to "4.00" mA.
- 4) Remove the jumper and the value is saved.

**20 mA OUTPUT SIGNAL CALIBRATION:** \*Ensure the output selection jumper is set to the 4-20 mA position (see photo #6 on page 13 for position).

- 1) Connect a digital multi-meter in series with the 4-20 output and set it to DC current.
- 2) Put the jumper onto "J2" position. Within 2-seconds, the tri-colour outer LED starts flashing amber for confirmation and the AST is now waiting for 20 mA calibration procedure to take place.
- 3) Use the "UP" and "DOWN" push-buttons to adjust the meter reading to "20.0" mA.
- 4) Remove the jumper and the value is saved.

## 11.0 CALIBRATING THE ANALOG OUTPUT, CONT'D.....

**10V OUTPUT SIGNAL CALIBRATION:** \* Ensure the output selection jumper is set to the 0-10V position (see photo # 6 on page 13 for position).

- 1) Connect a digital multi-meter in parallel with the 0-10VDC output and set it to DC current.
- 2) Put the jumper onto "J3" position. Within 2-seconds, the tri-colour outer LED starts flashing amber for confirmation and the AST is now waiting for 10 VDC calibration procedure to take place.
- 3) Use the "UP" and "DOWN" push-buttons to adjust the meter reading to "10.0 " VDC.
- 4) Remove the jumper and the value is saved.

*The transmitter circuit must now be re-initilaized before it can be used. Using Device Master, click "Save To Device" and the transmitter wakes up and is now in the active running mode.*

## 12.0 OPTIONS FOR AST SECOND GENERATION TRANMISTTER

**Note-1:** AST series transmitters utilizing solid-state sensors are supplied as a standard with a rugged, general purpose pvc enclosures.

**Note-2:** AST series transmitters utilizing catalytic combustible sensors are supplied as a standard with a rugged, water/dust tight, polycarbonate enclosure.

**Option-1:** Rugged, water/dust tight (installer must install correctly as per our instructions and use proper liquid tight conduit hubs) polycarbonate enclosures for transmitters with solid-state sensors. Photo on front outer page of this manual shows a transmitter installed in the water tight enclosure.

**Option-2:** Humidity sensor for RH compensation for transmitters with solid-state sensors. This sensor is installed internally.

**Option-3:** LED local digital display for transmitters utilizing either type of sensor. This display is installed behind the window opening of the transmitter where the tri-colour outer LED normally is viewed. When the display option is selected, the tri-colour LED is installed internally.

**Option-4:** Dry relay local contact rated 2 amps @ 30V for transmitters utilizing either type of sensor. The relay is installed on the circuit board internally. Reference photo # 7 on page 14 for location.

**Option-5:** Molded splash guard for transmitters utilizing either type of sensor. *Available only with water tight enclosure option.* If the application for a water tight enclosure is for a wet environment with the potential for wash down or a pressurized hose to be directed at the sensor, a splash guard is absolutely mandatory. Electrochemical sensors are very sensitive to excessive pressure and can easily be damaged by directing pressurized air or liquid at them. The splash guard is made of molded plastic and attaches to the outside of the enclosure door directly over the sensor opening with three stainless steel screws.

## 12.0 OPTIONS FOR AST SECOND GENERATION TRANSMITTER



PHOTO-12

SPLASH GUARD. ATTACHES TO THE FRONT OF WATER TIGHT ENCLOSURES

## 13.0 ACCESSORIES

### CALIBRATION KIT



Calibration kits and gases are available from the CETCI factory. Many gases are carried in inventory but not all. Check with any CETCI authorized distributor for availability of specific gas types. Reference photo example below.

PHOTO-13

### METAL PROTECTIVE GUARDS

AST series analog transmitters are all supplied in very rugged, non-metallic enclosures. However, in some applications more protection may be desired. CETCI can provide protective guards made from 16 gauge galvanized metal with a pattern of square perforations to permit air and gas to diffuse easily to the sensor.



PHOTO-14