

BACNET CONTROLLER
(INSTALLER SUPPLIED)
A
B
24V
GND

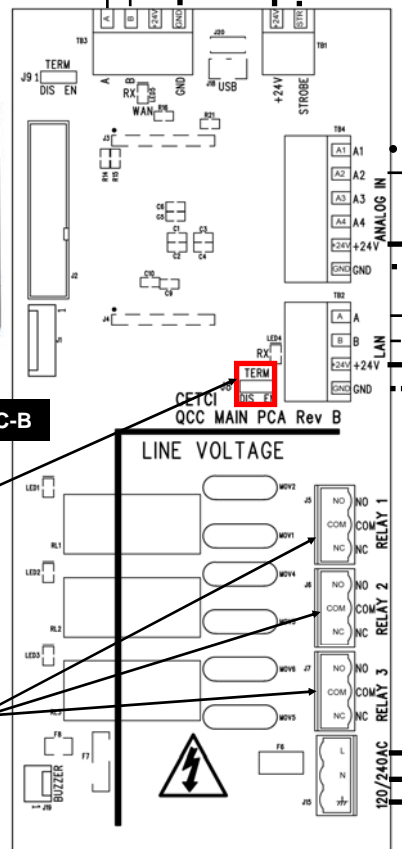

TERMINATION JUMPER IN EN POSITION IF FIRST DEVICE IN NETWORK CHAIN

THREE RELAY CONTROL WIRING TERMINALS. CONNECT TO COM & NC. DO NOT USE SOLID CORE WIRE. RELAYS OPERATE IN "FAIL SAFE" CONFIGURATON.

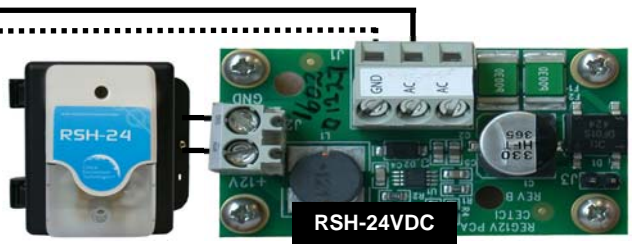
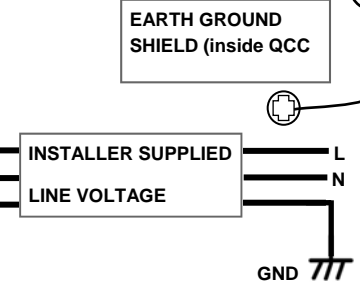

HOMERUN OR DAISY CHAIN POWER AND GND RUNNING TO ADDITIONAL ART TRANSMITTERS. NOTE THAT ONE SIGNAL WIRE MUST BE PULLED FOR EACH ART (UP TO FOUR) TRANSMITTERS ADDED. EARTH GROUND SHIELD NOT CONNECTED ON LAST DEVICE

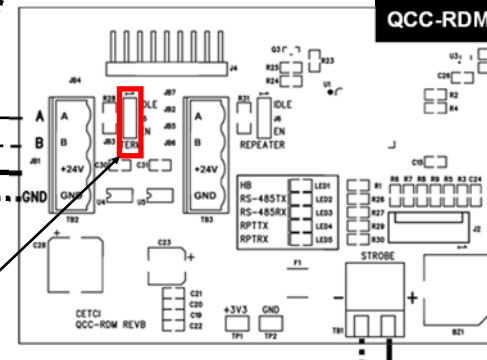
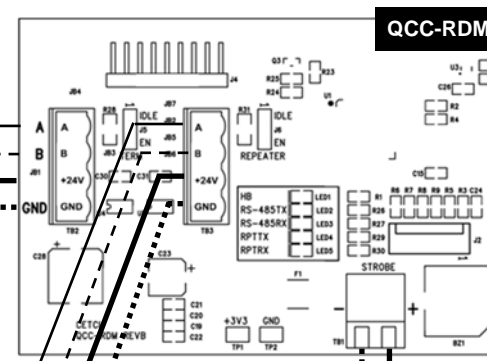
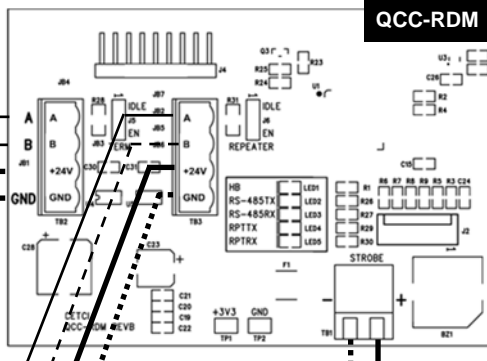
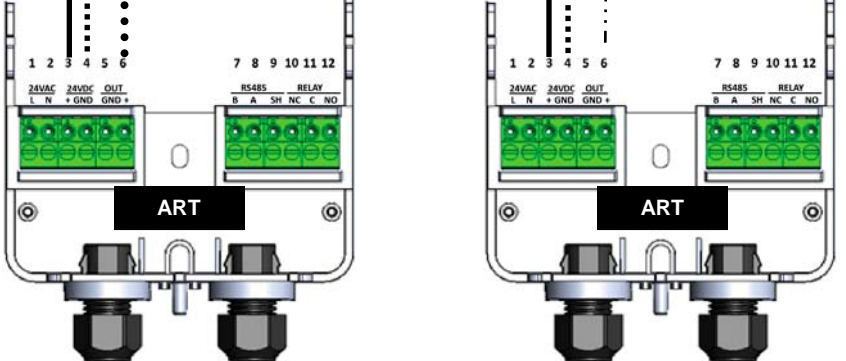

TERMINATION JUMPER IN EN POSITION IF LAST DEVICE IN NETWORK CHAIN

CRITICAL ENVIRONMENT TECHNOLOGIES CANADA INC.
www.critical-environment.com
QCC-B TO ART WITH QCC-RDM AND RSH-24VDC
WIRING CONNECTION DRAWING
REV-A August 23, 2016